

LINE	BBQ LINE
MODEL	PROPANE TANK DRAWER
NUM	

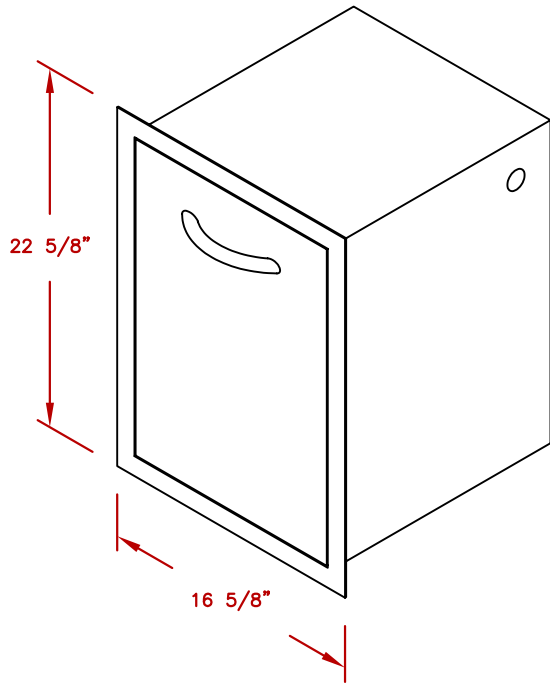

ISOMETRIC FRONT VIEW

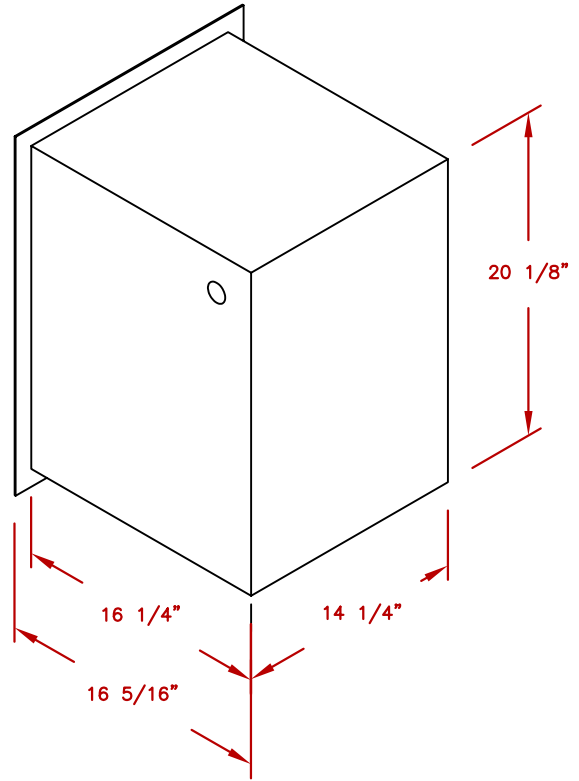

ISOMETRIC BACK VIEW

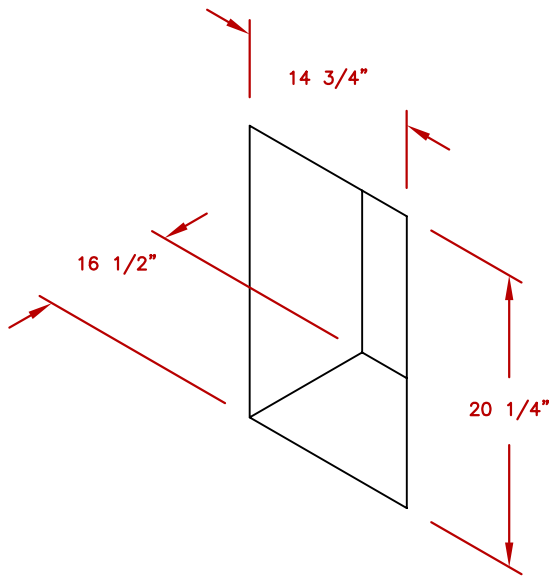

CUT OUT DIMENSION

	TITLE 2017 BARBECUE LINE DOORS & DRAWERS PROPANE TANK DRAWER	
	SCALE:	DWG NO. BBQ07857P
REVISED	REV. DESCR.	DWG BY G.GARCIA
		DATE 12/14/16

NOTE:  
DUE TO OUR CONTINUOUS IMPROVEMENT PROGRAM, ALL MODELS  
AND SPECIFICATIONS ARE SUBJECT TO CHANGE WITHOUT NOTICE.