



P4 and P5 Grills

BBQ13P04

BBQ13P05

United States and Canada

© 2013 LMS, Inc.

Owner's Manual



www.calflamebbq.com

Safety Instructions

Placement and Location	1
Set-Up	1
Operation	1
Maintenance and Repair	2
Storage	2
Precautions Regarding Children	2

Built-in Construction

Location of grill enclosure	3
Construction materials	3
Built-in Dimensions	4
Enclosure Ventilation	6
Plumbing for Side Burners	7
Electrical Supply Requirements	7

Installation

Installing Grills in Barbecue Islands	8
Installing the Rotisserie	8

Gas Connection

Leak Testing Procedure	9
LP Gas	10
Natural Gas	11

Using Your Grill

Basic Grill Operation	12
Grill Controls	13
Lighting the Burners	14

Heat Distribution on the Cooking Grates ..	15
Drop-in Griddle	15
Smoker Box	15
Cooking with the Rotisserie	16

Optional Grill Accessories

Sear Zone Infrared Burner	17
Pizza Brick Tray	17
Rotisserie Basket	17
Charcoal Tray	18

Cleaning and Maintenance

Stainless Steel Care and Cleaning	19
Cleaning the Interior of Your Grill	20
Covering Your Grill	21
Seasonal Cleaning	22
Light Bulb Replacement	24

Appendix

Troubleshooting	25
Converting from LP to NG	27
Installing Sear Zone Burners	30
Wiring Diagram	31
Replacement Parts	32
Limited Warranty	35

Read all instructions before you operate your grill.

WARNING

If the information in this manual is not followed exactly, a fire or explosion may result causing property damage, personal injury or loss of life.

Do not store or use gasoline or other flammable vapors and liquids in the vicinity of this or any other appliance.

Do not store an LP cylinder not connected for use in the vicinity of this or any other appliance. A fire resulting in serious injury or death may occur.

If you are installing a natural gas grill, you are responsible for ensuring that the natural gas line installed is safe to use. LMS will not be held responsible for an improperly installed gas line.

Save these instructions!

CONTACT INFORMATION

For customer service, please contact your authorized dealer immediately. If you need additional information and/or assistance, please contact:

LMS Customer Service Department
1462 East Ninth Street
Pomona, CA 91766.

Toll Free: 1-800-225-7727
Fax: 1-909-629-3890

Copyright 2013 LMS, Inc. All rights reserved. Duplication without written consent is strictly prohibited. Cal Flame™ is registered trademark.

Due to continuous improvement programs, all models, operation, and/or specifications are subject to change without prior notice.

LTR50001137, Rev. B
12/26/13

250-454

Safety Instructions

WARNING: Improper installation, adjustment, alteration, service or maintenance can cause injury or property damage. Read the installation, operating and maintenance instructions thoroughly before installing or servicing this equipment.

Placement and Location

- **Cal Flame™ grills are designed for outdoor use only.**
- Never locate this appliance in an enclosed room, under a sealed overhead structure, or in any type of enclosed area such as a garage, shed, or breezeway. Keep clear of trees and shrubs.
- Do not place this grill under or near windows or vents that can be opened into your home.
- Cal Flame™ grills are not intended for installation in or on recreational vehicles or boats.
- Maintain sufficient distance as to not overheat any overhead combustible material such as a patio cover.
- The area surrounding your new grill should be kept clean and free from flammable liquids and other combustible materials such as mops, rags or brooms, as well as solvents, cleaning fluids, and gasoline.
- Do not use the grill, grill cabinet, or area surrounding the grill as a storage area for flammable or plastic items. Do not store the liquid propane (LP) cylinder in the vicinity of this or any other appliance when it is not being used.

Set-Up

- Before installing built in grills in enclosures, copy all product information such as model number, serial number and type of grill (e.g. natural gas or LP) and store information in a safe place. This information is located on a plate located behind the grill and is visible when the hood is lowered or

DANGER

What To Do If You Smell Gas

- Shut off gas to the appliance.
- Extinguish any open flame.
- Open lid.
- If odor continues, keep away from the appliance and immediately call your gas supplier or your fire department.

on the right side of the chassis. There is an area on the back cover of this manual where you can write down this information.

- We recommend that a licensed contractor install your Cal Flame™ grill. Installation must conform to local codes, or in the absence of local codes, with either the *National Fuel Gas Code*, ANSI Z223.1 / NFPA54, *Natural Gas and Propane Installation Code*, CSA B149.1, or *Propane Storage and Handling Code*, B149.2), as applicable.
- Your Cal Flame™ grill must be plugged into a permanent, grounded 110V outlet with a dedicated 15A GFCI breaker in accordance with local codes or the *National Electrical Code*, ANSI / NFPA 70, or the *Canadian Electrical Code*, CSA C22.1.
- Do not use an extension cord to supply power to your Cal Flame™ grill. Such use may result in fire, electrical shock or other personal injury. Do not install a fuse in the neutral or ground circuit. A fuse in the neutral or ground circuit may result in an electrical shock hazard. Do not ground this appliance to a gas supply pipe or hot water pipe. Keep any electrical supply cords and the fuel supply hose away from any heated surfaces.
- To prevent fire and smoke damage, remove all packaging material before operating grill.
- Before you start cooking, clean the entire grill thoroughly with hot, soapy water. This is necessary to remove residual solvents, oil and grease used in the manufacturing process. The grates should also be thoroughly cleaned in the same manner.

Operation

- Do not use grill for other than intended use.
- In the event that a burner goes out, turn burner knobs to the full OFF position, fully open the grill hood and let it air out. Do not attempt to use the grill until the gas has had time to dissipate.
- Never use the grill if the drip pan is not properly installed. Drip pan should be pushed all the way to the rack located just under the grill. Fire or explosion can result from an improperly installed drip pan.
- Keep all electrical supply cords and the rotisserie motor cord away from the heated areas of the grill.

- Never use the grill or side burner in windy conditions. If used in a consistently windy area a windbreak will be required. Always adhere to the specified clearances listed in this manual.
- Never line the grill or side burners with aluminum foil.
- When the unit is not in use, be sure to turn off the gas at the LP tank.
- Do not install or operate your grill unit in such a manner that the cross ventilation openings are blocked. Fresh air must be able to pass through installed vents to safeguard against residual gas accumulation. Failure to allow proper ventilation may cause fire or explosion.
- When handling LP gas line and connectors, do not allow them to come in contact with any metal surfaces of the cabinet. Do not drop LP connectors.
- Do not use fuel such as charcoal briquettes in gas grills.
- Gas sources to the grill and side burners must be regulated. Do not operate grill or side burners if regulators have been removed, fire or explosion can occur.
- Never leave the grill and side burners unattended when in use. When using pots and pans, boil-overs will cause smoking and greasy boil-overs may ignite.
- Always use the proper size pan. Select utensils with flat bottoms large enough to cover the burner. The use of under-sized utensils exposes the sides of the utensils to direct contact with a portion of the flame. This can scorch utensils and hamper cleanup. Excessive flames on large stainless steel pots can result in permanent discoloration. For best results, we recommend commercial quality aluminum pans and utensils.
- Always position handles of utensils so they do not extend over adjacent work areas or cooking areas. This reduces the risk of burns, ignition of flammable materials, and spillage due to accidental contact with the utensils.
- Do not use water on grease fires. Never pick up a flaming pan. Turn the appliance off and smother the flaming pan with a tight-fitting lid, a cookie sheet or a flat tray. For flaming grease outside of the pan, smother it with baking soda or use a dry chemical or foam-type fire extinguisher.
- Never allow clothing, pot holders or other flammable materials come in contact with or be close to any grate, burner or hot surface until it has fully cooled. Never wear loose fitting or hanging garments while using your grill. Fabric may ignite and result in personal injury.
- When using the grill, do not touch the grill rack, burner grate, or immediate surroundings as these areas become extremely hot and can cause burns. Use handles or knobs.
- Only use dry pot holders and do not use a towel or other bulky cloth in place of pot holders. Moist or damp pot holders used on hot surfaces can cause burns.
- Do not heat any unopened glass or metal container of food on the grill. Pressure may build up and cause the container to burst, possibly resulting in serious personal injury or damage to the grill.
- Do not reach over your grill or any other surfaces when hot or in use.

Maintenance and Repair

- Spiders and other insects can nest in the burners of the grill and block the gas and airflow to the burner ports. This creates a dangerous condition that can result in a fire behind the valve panel. Inspect and clean the burners periodically and follow the guidelines in the Cleaning and Maintenance section of this manual.
- Unless specifically recommended in this manual, do not repair or replace any part of the grill. A qualified technician should perform all service. Any repairs made by a non-LMS approved dealer technician will void your warranty.

Storage

- When your gas grill is not in use, turn off the gas at the supply cylinder.
- Storage of a grill indoors is permissible only if the supply cylinder is disconnected and removed.

Precautions Regarding Children

- Never leave children unattended in the area where the grill is being used. Close supervision of children is necessary when any appliance is used near children.
- Do not store items of interest to children around or below the grill.
- Never allow children to sit or stand on any part of the grill.

Built-in Construction



Read these instruction before constructing your grill enclosure. Failure to follow these instructions may result in damage, injury, or death.

LMS Inc. will not be held responsible for property damage, injury, or death as a result of locating a grill enclosure in a non-approved location or using non-approved construction materials.

We strongly recommend that grill owners hire a contractor to construct the built-in enclosure.

In this section:

- Location of grill enclosure
- Construction materials
- Built-in dimensions
- Enclosure ventilation
- Plumbing for side burners
- Electrical supply requirements

Location of grill enclosure

Cal Flame grills are designed for outdoor use only.

Do not locate your grill enclosure in an enclosed area, which is any covered area that is walled on two, three, or four sides. This includes areas or rooms such as a garage, shed, breezeway, patio, cabana, etc.

Although some enclosed areas may have windows, screens, or ventilation systems, they are nevertheless considered to be hazardous and may cause damage, injury, or death. Enclosed areas are NOT approved for a grill enclosure.

Do not locate your grill enclosure in any vehicle, including recreational vehicles, campers, trucks, or boats.

To reduce the risk of personal injury caused by reaching over a hot appliance, avoid locating cabinet storage space directly above the outdoor grill.

Maintain sufficient distance as to not overheat any overhead combustible material. We recommend a minimum distance of six feet, measured from the top of the grill hood. Check with local inspectors and your homeowner's association.

Do not locate your grill enclosure under a sealed overhead structure.

The sides, bottom and back of the grill enclosure should not be any closer than 24" to combustible construction.

When planning your Cal Flame grill location, access to gas lines and 110V power supplies should be considered. If you are using natural gas, the location with the shortest gas line run is recommended. You may need a grounded, dedicated, 15A 110V GFCI power source for use of your appliances (e.g. lights, rotisserie, refrigerator, receptacles, etc.).

When determining a suitable location, consider factors such as exposure to wind, proximity to traffic paths, and windows that open into the home.

Locate the grill enclosure any place where there is adequate ventilation. The size and configuration of your house and yard will determine how you should locate your grill enclosure, but as a general rule, do not place it under or near windows that can be opened into your home.

Construction materials



DO NOT use combustible materials for the built-in construction.



Acceptable building materials: Brick, cinder block, steel frame, hardiboard, granite, tile, glass brick, concrete, cement, stucco, stone.



Unacceptable building materials: Wood of any sort, laminate or synthetic materials, plastics, linoleum, fiberglass.

In addition, we do not recommend using materials that are susceptible to damage or decomposition by weather, such as dry wall or plaster.

Built-in Dimensions

Plan the installation so that the electrical connection, gas shut-off valve, and pressure regulator are accessible inside the base enclosure. The gas valve shall be readily accessible for hand operation. A door on the enclosure to gain access to the gas valve is acceptable, provided it is non-locking and can be opened without the use of tools.

The design of the outdoor cooking enclosure must allow the LP gas cylinder to be connected and disconnected and the connections inspected and tested.

There must be a minimum clearance of 2 inches (51mm) between the floor of the LP-gas cylinder enclosure and the ground.

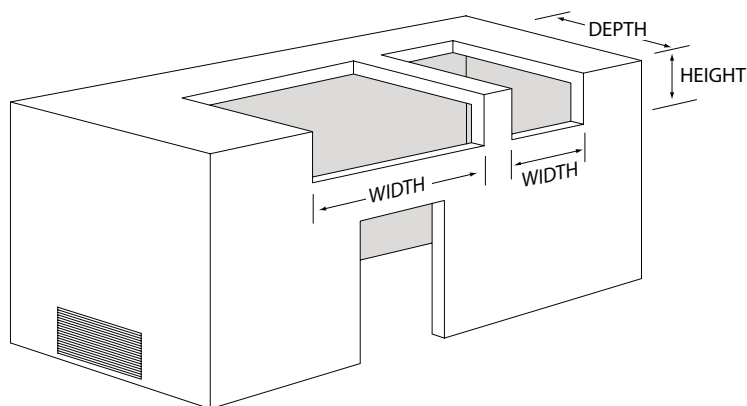

The dimensions shown below are for Cal Flame appliances only.

Model	Description	Width	Depth	Height
BBQ13P04	P4 Premium Four Burner Grill	31"	22 ¼"	9 ¼"
BBQ13P05	P5 Premium Five Burner Grill	38 ¾"	22 ¼"	9 ¼"

Model	Description	Width	Depth	Height
BBQ08954P	Deluxe Side by Side Burner	25 ¼"	12 ½"	7 ¼"
BBQ08899P	Deluxe Double Side Burner	12 ¼"	22"	7 ¼"

Built-in Dimensions cont.

The dimensions shown below are for Cal Flame appliances only.

Model	Description	Width	Depth
BBQ08953P	Side By Side Flat Burner	24 ¼"	19 ¾"
BBQ08852P	Single Flat Side Burner	11 ½"	17 ¾"

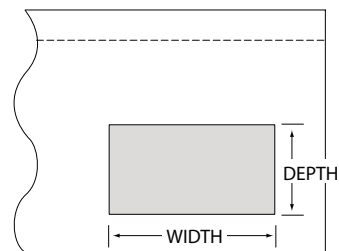
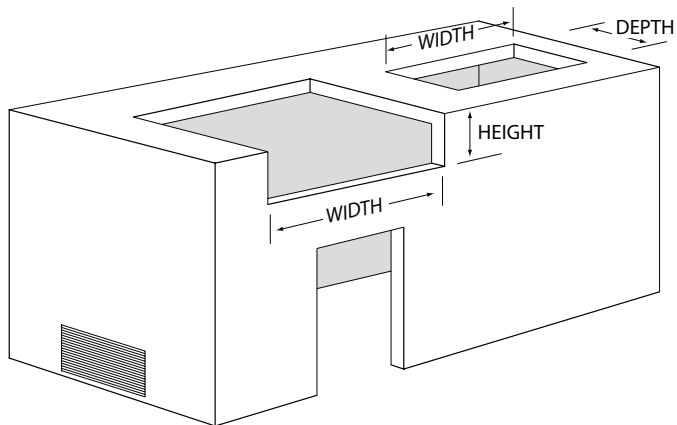

Top view of enclosure with back splash

The back edge of the grill must maintain a minimum clearance of 8" from non-combustible back splash materials.

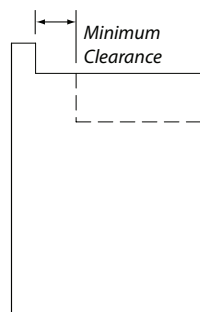

Side view of enclosure with back splash

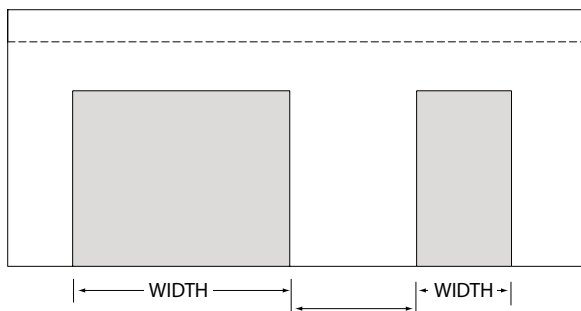

12" Minimum Distance
Between Grill and Side Burner

Top view of enclosure with back splash

Enclosure Ventilation

For proper ventilation, the base structure must be constructed using one of two designs:

- 1 An enclosure with one side open

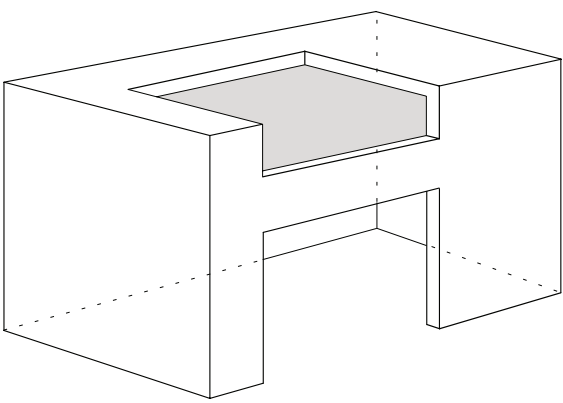

- 2 An enclosure having four sides, a top, and bottom

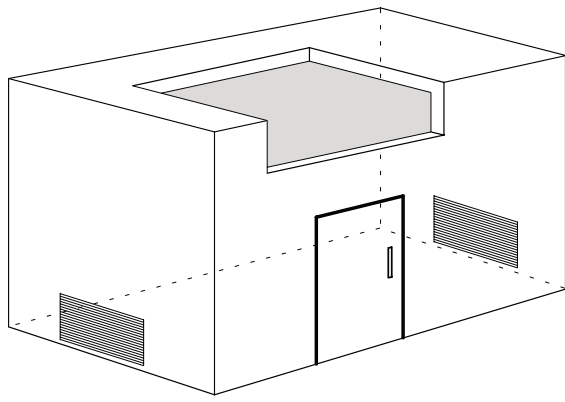

At least two ventilation openings at cylinder valve level shall be provided in the side wall, equally sized, spaced at 180 degrees and unobstructed.

Each opening shall have a total free area of not less than 10 square inches (254 square mm).

Ventilation openings shall be provided at floor level and shall have a total free area of not less than 10 square inches (254 square mm). If the ventilation openings at floor level are in a side wall, there shall

be at least two openings. The bottom of the openings shall be at floor level and the upper edge no more than 5 inches (127mm) above the floor. The openings shall be equally sized, spaced, and unobstructed.

LP-gas cylinders should be ventilated by openings at the level of the cylinder valve and the floor level. The effectiveness of the openings, for purposes of ventilation, shall be determined with the LP-gas supply cylinder in place.

Plumbing for Side Burners

1. Assemble a 3/8" pipe nipple to the 3/8" pipe tee using Teflon tape or pipe sealant. Use only sealant that is approved for use on LP gas.
2. Install the pipe tee assembly to the grill intake pipe. Tighten assembly and align the branch opening of the tee with the hole of the cabinet.
3. Connect the flexible hose (male end) to the pipe tee.
4. Install the side burner into the island by simply setting it in place.
5. Connect the female end of the flexible hose to the side burner intake pipe.
6. Connect gas supply to the grill.
7. Check for gas leaks using soap water solution.

Items Included with Barbecue

- 1) "T" adapter, 3/8"
- 2) 2 hose fittings, 3/8"
- 3) Regulator with hose

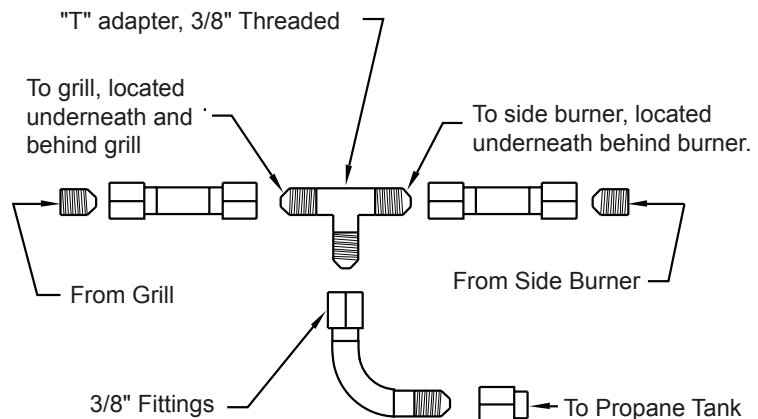
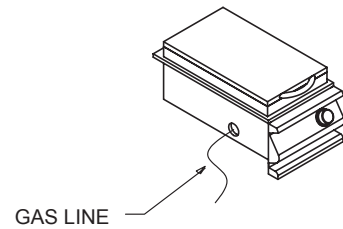

Electrical Supply Requirements

Your Cal Flame grill must be plugged into a permanent, grounded 110V outlet with a dedicated 15A GFCI breaker in accordance with local codes or the *National Electrical Code, ANSI / NFPA 70*, or the *Canadian Electrical Code, CSA C22.1*.

It is the owner's responsibility to ensure that the electrical connection to this appliance is properly installed. We recommend a contractor or licensed electrician install a dedicated 110V electrical service for your grill.

Do not use an extension cord to supply power to your Cal Flame grill. Such use may result in fire, electrical shock or other personal injury.

Do not install a fuse in the neutral or ground circuit. A fuse in the neutral or ground circuit may result in an electrical shock hazard.

Do not ground this appliance to a gas supply pipe or hot water pipe.

Use copper wire only. The use of aluminum wire may result in unsatisfactory connections.

Install 120VAC, 15 Amp duplex outlet in an accessible location under the grill inside the base enclosure.

Locate the electrical supply box inside the built-in enclosure within reach of the power cord so the connection is accessible when the grill is completely installed in the enclosure.

Installation

Installing Grills in Barbecue Islands

You will need a second person to help you to avoid damaging the grill, the transformer, or your barbecue island.

Before installing a grill or side burner in any island or cut out, make sure that the opening is not bigger than the outside frame of the grill unit. The grill should rest on the lip of the frame. For drop-in accessories, adequate cross ventilation must be designed into enclosure to ensure the drop-in grill or side burner does not become overheated.

Pay careful attention to the location of gas lines. Gas lines should be routed away from sources of heat and should make as few bends as possible.

Check to see if gas line connections will be accessible when grill is installed.

- If gas line connections are not easily accessible when the grill is installed, support the grill above

counter level and attach the gas lines to the grill. When the gas connections are made, slide the grill into the cut out.

- If gas line connections are accessible when the grill is installed, slide the grill into the cut out and then attach the gas lines.

Be very careful not to kink gas lines when lowering the grill or side burner into the cut out.

Keep your fingers away from where the grill will be supported on counter. Your fingers could become trapped and serious injury could occur.

Check to make sure the grill is level and is supported around the entire outside edge. If the grill is not level or is unstable, use non-combustible shims under the outside lip to stabilize it.

Perform the leak test procedure as described earlier in this manual.

Installing the Rotisserie

Attach the two brackets to the sides of the grill, one on each side, using two screws as shown below.

Slide the rotis motor on one of the brackets as shown below. The rotis motor will work on either side of the grill.

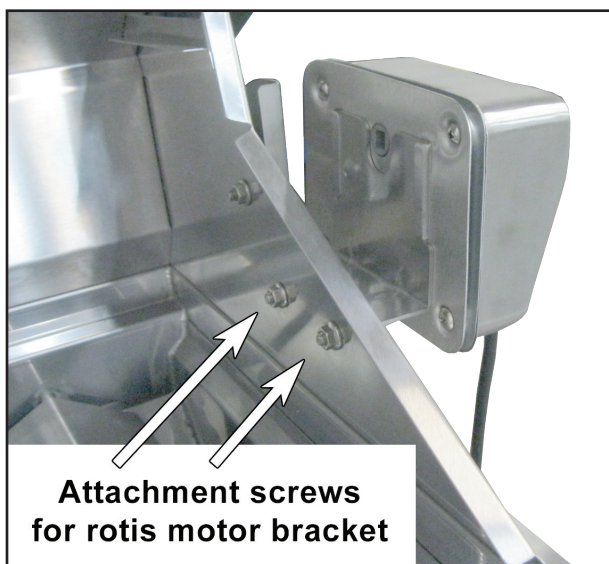

Gas Connection

Gas Requirements and Connection

IMPORTANT: The Cal Flame grill is manufactured to operate on liquid propane (LP). However, it can be converted to operate on natural gas (NG) by an authorized service technician. Consult your Cal Flame dealer for information on converting your gas grill.

Owners must not convert their grills themselves. Attempting to convert the grill from LP to NG may result in serious injury and will void the warranty coverage.

If you do not have an updated filler valve on your existing propane tank, you will need to purchase one at your local hardware store. Without it you will not be able to attach your tank to your Cal Flame™ grill or refill the tank at your local propane refill station.

Leak Testing Procedure

Perform a leak test at least once a year whether the gas supply cylinder has been disconnected or not. In addition, whenever the gas cylinder is connected to the regulator or whenever any part of the gas system is disconnected or replaced, perform a leak test.

As a safety precaution, remember to always leak test your grill outdoors in a well-ventilated area. Never smoke or permit sources of ignition in the area while doing a leak test. Do not use a flame, such as a lighted match to test for leaks. Use a solution of soapy water.

1. Prepare a leak testing solution of soapy water by mixing in a spray bottle one part liquid soap to one part water.
2. Make sure all the control knobs are in the OFF position.
3. Turn on the gas.
 - a. On natural gas systems, turn the main feed valve to the grill.
 - b. On LP systems, turn the cylinder valve knob counter clockwise one turn to open.

4. Apply the leak-testing solution by spraying it on joints of the gas delivery system. Blowing bubbles in the soap solution indicates that a leak is present.
5. Stop a leak by tightening the loose joint or by replacing the faulty part with a replacement part recommended by the manufacturer. Do not attempt to repair the cylinder valve if it is damaged. The cylinder must be replaced.
6. Turn all control knobs back to the full OFF position.

If you are unable to stop a leak:

1. Turn all control knobs back to the full OFF position.
2. Shut off the gas supply to the grill and release pressure in the hose and manifold by pushing in and turning any of the control valves one quarter turn counter-clockwise.
3. On LP systems, remove the cylinder from the grill.
4. Call an authorized gas appliance service technician or an LP gas dealer.

Do not use the appliance until the leak is corrected.

LP Gas

Tank Requirements

For plumbed-in LP installation, use a convertible regulator and set it for LP gas.

Maximum line pressure for plumbed-in propane is 14" WC (3.5 kPa). Minimum line pressure for propane is 11" WC.

The grill unit must be used with the gas pressure regulator. The regulator will control and maintain a uniform gas pressure in the manifold. The burner orifices have been sized for the gas pressure delivered by the regulator.

WARNING: Attempting to operate the grill unit without the gas regulator installed could cause an explosion and possible death.

Cylinder Specification

Any LP gas supply cylinder used with this grill must be:

- Constructed and marked in accordance with the *Specifications for LP-Gas Cylinders* of the U.S. Department of Transportation or the National Standard of Canada, *CAN/CSA-B339, Cylinders, Spheres and Tubes for Transportation of Dangerous Goods; and Commission*, as applicable.
- Approximately 12 inches in diameter and 18 inches high.

The maximum fuel capacity is 20 lbs. of propane, or 5 gallons. Full cylinder weight should be approximately 38 lbs. (43.7 lbs. nominal water capacity.) Never fill the cylinder beyond 80% full.

Place the dust cap on the cylinder valve outlet whenever the cylinder is not in use. Only install the type of dust cap on the cylinder valve outlet that is provided with the cylinder valve. Other types of caps or plugs may result in leakage of propane.

LP Gas Hook Up

An enclosure for an LP gas cylinder shall be vented by openings at the level of the cylinder valve and at floor level. The effectiveness of the openings for purposes of ventilation shall be determined with the LP-gas supply cylinder in place. This shall be accomplished in one of the following manners:

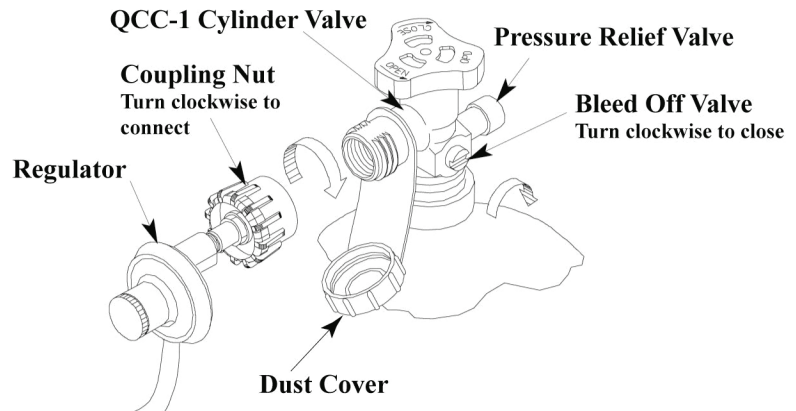

1. One side of the enclosure shall be completely open.
2. Enclosures that have four sides, complete with a top and bottom:
 - a. At least two ventilation openings at cylinder valve level shall be provided in the sidewall, equally sized, spaced at 180° (3.14 rad), and unobstructed. Each opening shall have a total free area of not less than one square inch per pound (7.1 cm²/kg) of stored fuel capacity, and not less than a total free area of 10 square inches (64.5 cm²).
 - b. Ventilation openings shall be provided at floor level and shall have a total free area of not less than one square inch per pound (7.1 cm²/kg) of stored fuel capacity and not less than a total free area of 10 square inches (64.5cm²). If ventilation openings at floor level are in a sidewall, there shall be at least two openings. The bottom of the openings shall be at floor level and the upper edge no more than 5 inches (127 mm) above the floor. The openings shall be equally sized, spaced at 180° (3.14 rad) and unobstructed.
 - c. Every opening shall have minimum dimensions so as to permit the entrance of a 1/8 inch (3.2 mm) diameter rod.

Transporting and Storing LP Gas

Transport only one cylinder at a time. Ensure the cylinder is secured in an upright position with the control valve turned off and the dust cap in place. Store cylinders outdoors and out of reach of children. Do not store cylinders in a building, garage, or any other enclosed area.

Natural Gas

Requirements

Always check the rating plate to make sure the gas supply you are hooking up to is the gas type the grill is manufactured for.

IMPORTANT: Never connect the grill to an unregulated gas supply.

The installation of this appliance must conform with local codes or, in the absence of local codes, to the national fuel gas code, ANSI Z223.1a-1998. Installation in Canada must be in accordance with the standard CAN/CGA-B149.2, Propane Installation Code.

A licensed contractor or local gas company representative must perform all natural gas connections.

Ensure that the service supplying the grill is fitted with a shut off valve conveniently positioned near the grill and giving ease of access.

The grill must be isolated from the gas supply piping system by closing its individual manual shutoff valve during any pressure testing of the gas supply piping system at test pressures equal to or less than 0.5 psi (3.5 kPa).

The grill and its individual shutoff valve must be disconnected from the gas supply piping system during any pressure testing of that system at test pressure in excess of 0.5 psi (3.5 kPa).

Your Cal Flame™ grill for use with natural gas comes equipped with its own regulator that **MUST NOT** be removed. If, this regulator needs to be replaced use only the type specified by Cal Flame™ for this appliance.

Connection

1. Slide the grill forward to gain access to the regulator and gas connection point in the rear.
2. Remove the rear panel from the barbecue to gain access to the regulator and gas connection point.
3. Connect a suitable flex connector to the grill regulator.
4. Check the grill controls to ensure all control valves are in the full OFF position.
5. Turn on the main gas supply and check all connections for leaks using soapy water as described in the leak testing procedure section.

Warning: If you see bubbles in the soapy solution at any of the connections, turn off the gas supply and tighten the connection. If tightening the connection does not seal the leak, it may be necessary to replace the flex hose.

Using Your Grill

Read all instructions before you operate your grill.

We recommend you wash your entire grill with soap and water prior to lighting it for the first time. Oils are used during the manufacturing process and some residual oil may still be on the stainless steel parts of your grill. Washing will reduce the possibility of discoloration. We also recommend you keep your grill covered when not in use. This will minimize the amount of dust and dirt that accumulates on your grill and extend the life of your grill.

Remember to use your Cal Flame grill safely by following these reminders:

- It is dangerous to use barbecue grills and side burners in any manner other than for what it is designed for.
- Do not use charcoal in a gas grill or side burner.
- Do not heat sealed containers such as cans or jars on grills or side burners. Explosion may result resulting in injury or death. Any sealed container, such as a pressure cooker, must have a properly operating pressure relieve valve to minimize explosion hazard.
- Never put combustible material such as paper, cloth, or flammable liquids on your grill at any time. Do not use grill, side shelves, cabinets, or any area around grill to store flammable materials.
- Never operate main burners and rear infrared convection burners at the same time. Excessive grill temperatures will result.

Basic Grill Operation

Before lighting, make sure all burner controls are off. Do not attempt to light the burners if the smell of gas is present. Check the connection with a soap and water solution after attaching the hose. For LP units, make sure there is gas in the tank and it is sitting upright. For natural gas units, make sure the shut off valve is on.

1. Make sure the drip tray is in place.
2. Light the grill burners using the instructions on the previous page.
3. Turn the control knob to HIGH and preheat the grill for 15 minutes. Close the top cover during the appliance preheat period.
4. Place the food on the grill and cook to desired completion. Adjust heat setting if necessary. You may set the control knob to any position between HIGH and LOW.
5. Allow the grill to cool and clean the drip tray after each use.

Do not leave the grill unattended while cooking.

Warning

NEVER cover the entire cooking or grill surface with griddles or pans. Overheating will occur and burners will not perform properly when combustion heat is trapped below the cooking surface.

CAUTION: NEVER spray water on a hot gas unit. This may damage porcelain or cast iron components.

Grill Controls

The controls shown below are for the P4 and P5 drop-in grills. Familiarize yourself with these controls before lighting your grill.

The push button ON / OFF switch controlling the halogen light is located on the control panel at the front left side.

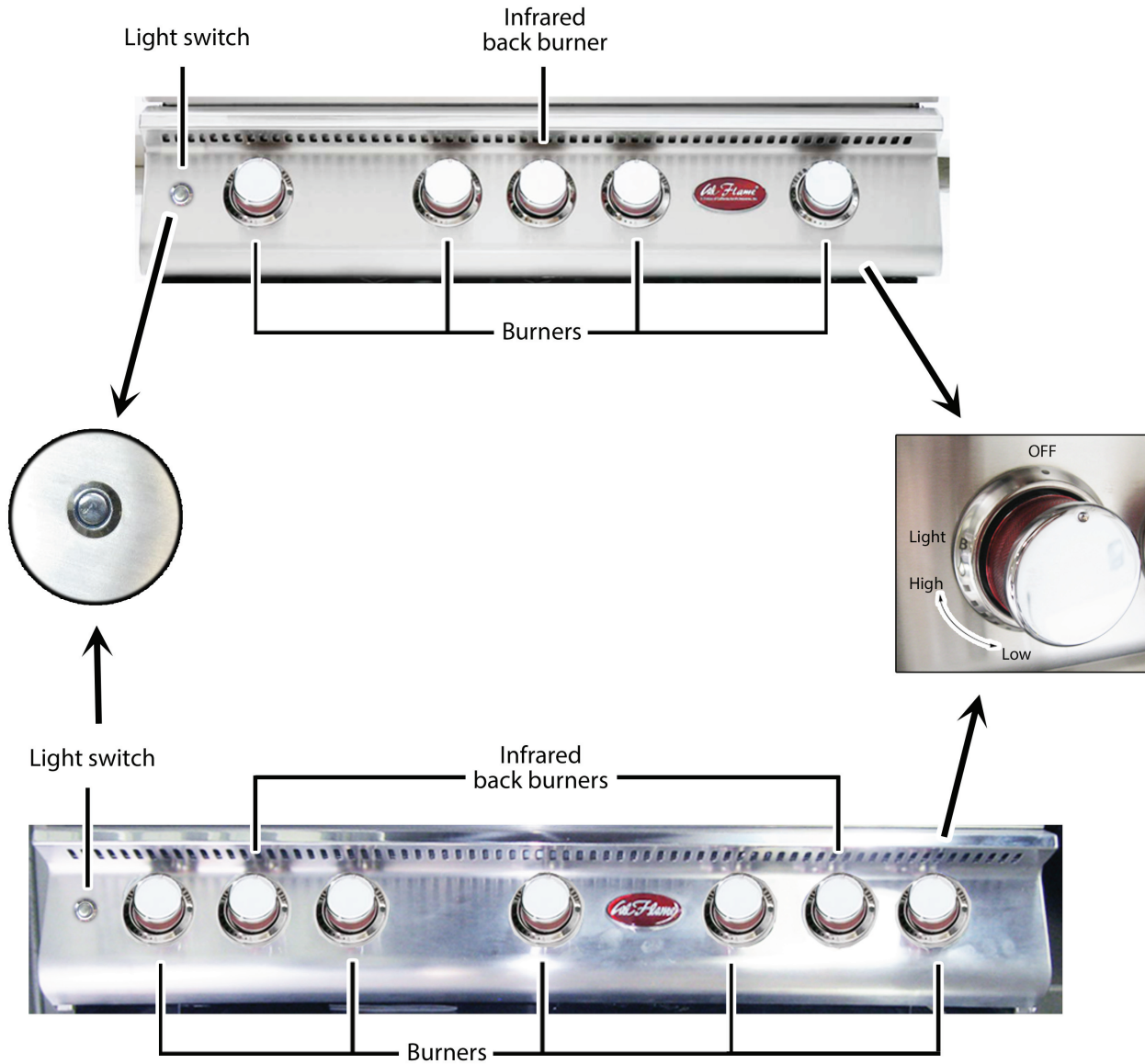

Lighting the Burners

Each time you light the grill, check the following:

- Inspect the hose before using the grill. If there is excessive abrasion or wear, or if the hose is cut, it must be replaced prior to using the grill. If you need a replacement hose, contact your Cal Flame dealer.
- Ensure the area around the barbecue is clear of flammable substances such as gasoline, yard debris, wood, etc.
- Ensure there is no blockage of the airflow through the vent space located below the face of the unit.
- When using propane gas, keep the special ventilation openings in the enclosure free and clear of debris.
- If connected to a propane cylinder, carefully inspect the rubber hose attached to the regulator before each use.
- Ensure the propane cylinder, regulator, and rubber hose are installed in a location not subject to heating above 125° F (51° C).
- Ensure the burner flames burn evenly along both sides of each burner with a steady flame (mostly blue with yellow tipping). If burner flames are not normal, check the orifice and burner for insects or insect nests.
- Ensure the in-line gas valve or gas cylinder valve is always shut OFF when the barbecue is not in use.
- Do not operate the side burner with its cover closed or the back burner with its cover installed.

Electronically Lighting the Burners

1. Open the hood.
2. Keep your face as far away from the burners as possible.
3. Press and rotate the burner knob counter clockwise past the light position to HIGH. You will hear a loud click as the electronic lighter produces a spark.
4. Listen for the sound of the gas igniting. If the burner does not light on the first try, repeat immediately.
5. If the burner does not light after three attempts, turn the control knobs to the OFF position. Wait five minutes until the gas clears before attempting to light it again.
6. Repeat the procedure or try the manual lighting procedure below.
7. Upon successful lighting, repeat the process on the other burners you wish to light.
8. To shut off the burners, rotate the knob and turn to OFF. It is normal to hear a popping sound when the burners are turned off.

Manually Lighting the Burners

WARNING: Do not use standard matches or cigarette lighters to perform match lighting procedures. Serious burns can occur and lighters can explode.

1. Open the hood.
2. If you have just attempted to light the burner, allow five minutes for any accumulated gas to dissipate.
3. Slide out the drip tray from the grill.
4. Keep your face as far away from the burners as possible.
5. Light and insert a long stem match, holding it near the burner ports.
6. Push in and turn the control knob just past the LIGHT position to HIGH.
7. Listen for the sound of the gas igniting. If the burner does not light after five seconds, turn the control knobs to the OFF position. Wait five minutes until the gas clears before attempting to light it again.
8. If the burner does not light after several attempts see Troubleshooting Guide in the back of this manual.

Heat Distribution on the Cooking Grates

When you place food your Cal Flame grill, remember that the back of the grill tends to be hotter than the front.

As your food cooks, you should periodically shift it to different spots on the cooking grates to ensure everything cooks evenly without burning.

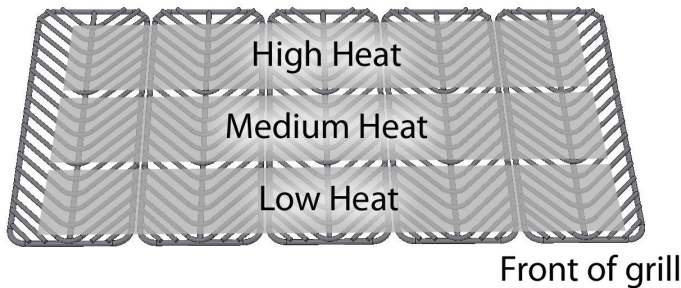

Drop-in Griddle

Remove any two cooking grates for the griddle space and set the griddle in the empty space. You can the griddle to the left, center, or right side of the grill

Light the grill and turn on the burners under the griddle to high for several minutes to heat the griddle.

The griddle is slightly bowed in the center to allow grease to run off while you are cooking.

To remove the griddle, wait until it cools down when done cooking. Use both hands when removing the griddle.

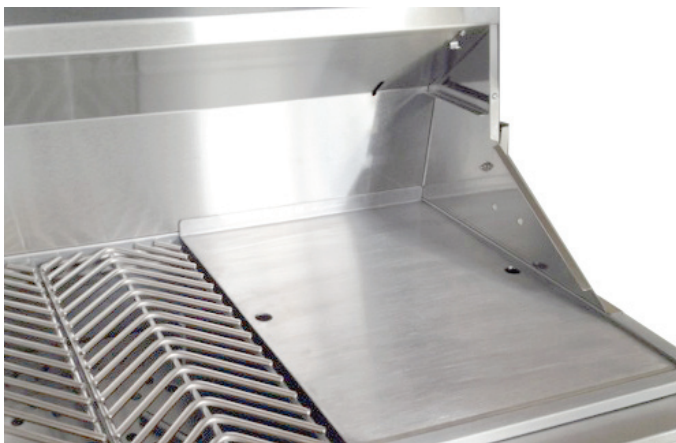

Smoker Box

Place wood chips or charcoal in the smoker box and place it on the grates.

Ignite the burner under the smoker box and turn it up to high.

Let it burn until the wood chips start to smoke. This should take 7 to 10 minutes. Then lower the heat to low.

When you are finish grilling, let the smoker box cool before emptying the ash.

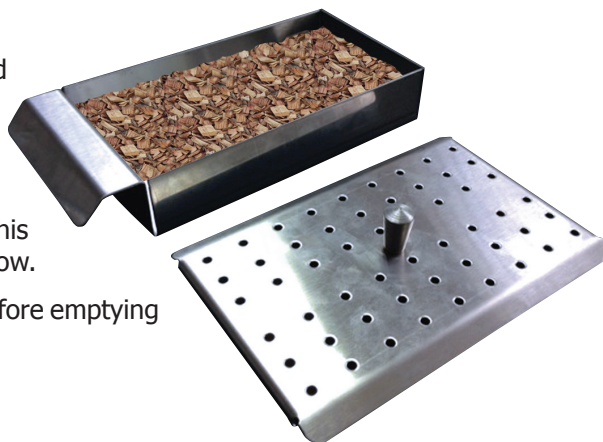

Cooking with the Rotisserie

The rotisserie cooks with the infrared back burner, which provides intense searing radiant heat. The location of the rotisserie and burner allows the placement of a rotisserie-basting pan (NOT included) beneath the food to collect juices and drippings for basting and gravy.

Before you can use the rotisserie, you need to mount the brackets and motor to the grill. See page 8 for instructions.

Loading food on the rotisserie rod

1. Hold the handle firmly while sliding one of the fork assemblies (prongs facing away from the handle) onto the rod.
2. Push the rod through the center of the food, then slide the other holder (prongs toward the food) onto the rod.
3. Center the meat on the rod and push the fork assemblies firmly together.
4. Tighten the thumbscrews.
5. To secure any loose portions of your meat, use butcher string (never use nylon or plastic string).
6. Place a basting pan under the food to collect the drippings.

Cooking with the rotisserie

1. Remove the warming rack.
2. Place the pointed end of the rotis rod into the motor and rest the threaded end on the support at the side of the grill. When the rod is pushed as far as possible into the motor, the grooved end of the rod should rest on the right side bracket.
3. If necessary, to offset unbalanced loads, slide the counter weight on to the rod. With the counter weight loose, allow the loaded rod to rotate and come to a stop. Now rotate the counter weight above the rod in a vertical position and tighten the thumbscrew. You can slide the counter weight away from or closer to the rotisserie rod as needed for balanced operation.
4. Light the infrared back burner. It will reach cooking temperature in about one minute. The orange/red glow will even out in about five minutes. The back burner flame can be adjusted to the level of intensity you prefer.



Optional Grill Accessories

These grill accessories are optional and may be ordered directly from www.quickbbqparts.com.

Sear Zone Infrared Burner

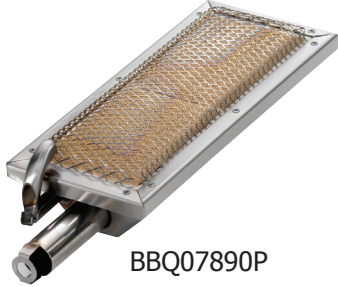

BBQ07890P

The Sear Zone infrared burner can be use in place of any regular burner. Producing intense infrared heat, it cooks quickly with searing heat to seal in juices. (Note: The Sear Zone infrared burner is NOT the same as the infrared back burner used with the rotisserie.)

Instructions for installing the optional Sear Zone burner are on page 30.

Pizza Brick Tray



BBQ07900

You can use your grill as a pizza oven using the pizza brick tray. Made of stone and stainless steel, it fits on any Cal Flame grill and is large enough to cook a large sized pizza.

Set the tray on the grates, set the burners to medium heat, and heat up your grill for about 10 minutes. Place the pizza on the tray and close the hood. Depending on the size of the pizza, it will need between 10 to 20 minutes to cook.

Rotisserie Basket



BBQ08892

Perfect for roasting vegetables or cooking fish, this rotisserie basket makes preparing these foods and others easy!

Open the rotisserie basket and set your food inside. Close and clamp it shut, then slide the rotisserie rod lengthwise through it. You can use it with either the standard burners or the infrared back burner.

Charcoal Tray



BBQ11859

Use Turn part of your Cal Flame grill into a charcoal and gas grill.

Turn off the gas and wait for the grill to cool before setting the Charcoal Tray in place.

Placement

1. Remove two grates (left or right side) and the flame tamers (the angular metal pieces covering the burners). Do not remove the burners.
2. Set the charcoal tray in the grilling area so that the notches in the side rest on the round metal posts attached to the inside of the grill area. The charcoal tray will resting over, but not ON, the burners.
3. Place the ash screen in the Charcoal Tray.

Using the Charcoal Tray

The Charcoal Tray is designed and intended to be used with plain charcoal. Quick-light charcoal can produce excessive heat and may be dangerous.

Make sure the drip tray is in the grill before you begin.

Keep the hood up until you are ready to cook.

1. Arrange charcoal in the tray.
2. Replace the grates.
3. Ignite both burners under the Charcoal Tray and turn them up to HIGH.
4. Let them burn until the charcoal remains lit without help from the burners. This should take 7 to 10 minutes.
5. When the charcoal is ready, turn off the burners.
6. Lower the hood if you wish to use the grill as a smoker.

Removal and Clean-up

When the grill has cooled and the charcoals are dead, clean the grill as described in the grill owner's manual.

Remove ash from the Charcoal Tray immediately after use. Do not let it accumulate. Do not use the grill again until charcoal ash has been removed from the Charcoal Tray and the drip tray.



Never use the Charcoal Tray over a Sear Zone infrared burner.



NEVER use charcoal in a gas grill without the charcoal tray. Doing so will void your warranty.

Cleaning and Maintenance

To ensure safe and proper maintenance, we recommend you follow these directions carefully.

Clean internal parts of the grill regularly as determined by the amount of use and foods cooked. The entire grill should be cleaned at least once a year.

In addition, keep the area around your grill clear and free from combustible materials, gasoline, and other flammable vapors and liquids. Do not obstruct the flow of combustion and ventilation air.

DISCONNECT ELECTRICAL SUPPLY BEFORE CLEANING ANY PART OF THE GRILL.

These instructions describe the best way to care for your stainless steel. They apply to grills and barbecue islands with stainless steel fixtures.

Although stainless steel grills will discolor and accumulate grime with regular use, they can keep their original shine with periodic cleaning. We strongly recommend using a surface protectant to prevent smudging and surface rust from accumulating.

The easiest way to clean the grill is immediately after cooking is completed. Doing so will extend the life of your grill, prevent grease fires, and present a pleasant appearance while you grill.

Stainless Steel Care and Cleaning

All exposed stainless steel surfaces require special attention if you want to keep them looking clean and bright. Following these simple instructions will help avoid scratching or damaging the finish and keep your stainless steel attractive.

Cleaning instructions for grill interiors, including racks and burners, are described after this section.

1. Clean

Thoroughly clean stains, food, and grime using a sponge or damp cloth with warm water and a mild dish soap. Use Fantastik or Formula 409 to remove heavier soil.

2. Rinse

Thoroughly rinse all surfaces and dry them completely with a clean towel. Do not allow stainless steel to air dry.

3. Polish

We strongly recommend that you apply a surface protectant to all exposed stainless steel surfaces.

Spray a small amount of WD-40 or Sheila Shine on a piece of paper towel and rub with the grain over the surface of the appliance. Using a clean terry cloth or paper towel, polish the appliance by rubbing with the

Cleaning Products and Materials

DO NOT USE these common cleaning products and materials – they will damage the surface of your stainless steel.

- CLR
- Lime-Away
- Oven cleaner
- Cleansers such as Ajax or Comet
- Ammonia
- Bleach
- Chlorine
- Steel wool pads
- Wire brushes
- Scrapers
- Pumice

We recommend these products for cleaning your stainless steel:

- Mild dish detergent such as Dawn
- Formula 409
- Fantastik
- Instant Rust Out (exterior ONLY)
- WD-40 (exterior ONLY)
- Sheila Shine (exterior ONLY)

We have had best success with Instant Rust Out, but WD-40 works very well too. Instant Rust Out is available in some hardware stores. WD-40 is widely available.

Baking soda, lemon oil, olive oil, vinegar, or club soda can also be effective for cleaning light soil on all stainless steel surfaces.

Do not use steel wool or wire brushes to scrub your grill.

For light soil, use a damp sponge or cloth.

For heavier stains, use a Scotch-Brite scrubber or similar product.

grain until excess liquid is removed and the surface shines. It should not be oily to the touch, however some residue is acceptable.

Furniture polish, such as Old English, can be effective for polishing stainless steel and protecting the surface.



Caution

Do not use Instant Rust Out, WD-40, or Sheila Shine near food or on food preparation surfaces as it is a health hazard. This includes the interior of the grill, grill racks, stainless steel sinks, the inside of cabinets, warming drawers, and ovens.



Fire Hazard

NEVER spray WD-40 or Sheila Shine near an open flame! These products are extremely flammable while in their aerosol forms.

Rust Removal

It is a common misconception that stainless steel does not rust. It does not stain, corrode, or rust as easily as ordinary steel (it *stains less*), but it is not stain-proof. If not properly protected and maintained, it can corrode, pit, and discolor.



Important

Because salt will accelerate rust and corrosion, grill or barbecue island owners who live near the beach need to be diligent in maintaining their stainless steel hardware. You need to clean and polish your stainless steel frequently, apply a protectant, and ensure water does not collect and puddle.

There are two methods of rust removal we recommend:

1. Rust removal with Instant Rust Out:

Spray exterior stainless steel surfaces with Instant Rust Out. Let it stand for about 30 seconds, then wipe with a clean cloth. Apply a second time if necessary.

Instant Rust Out will leave a white residue which can be rinsed off with water. Wipe the grill dry with a clean cloth and apply Sheila Shine or WD-40 as a surface protectant.

2. Rust removal with WD-40 or Sheila Shine:

Spray exterior stainless steel surfaces with WD-40 or Sheila Shine and wipe down with a dry cloth or paper towel until surface is free of rust. If there is significant rust or corrosion, use a Scotch-Brite scrubber.

Both of these products will act as a surface protectant and help resist smudges, stains, and rust.



Caution

Although nitric acid (also called aqua fortis) can be effective for rust removal, it is a highly corrosive chemical. Because of the potential for injury or damage to your stainless steel, we do not recommend using nitric acid.

Cleaning the Interior of Your Grill

1. Thoroughly clean stains, food, and grime using a sponge or damp cloth with warm water and a mild dish soap. Use Fantastik or Formula 409 to remove heavier soil.
2. Thoroughly rinse all surfaces and dry them completely with a clean towel. Do not allow water to accumulate and puddle on stainless steel. Water from various sources such as garden hoses contains iron which will give the appearance of rusting on stainless steel. If allowed to stand for long periods of time on stainless steel, it will cause pitting.
3. The racks, flame tamers, and flavor bars can all be removed for cleaning and are dishwasher safe.

Burners

Spiders and small insects occasionally inhabit or make nests in the burner tubes, obstructing the gas flow. Sometimes this results in a type of fire in and around the gas tubes called "flashback". To reduce the risk of flashback, this procedure should be followed at least once a month or when your grill has not been used for an extended period of time.

IMPORTANT: Prior to starting this procedure, turn OFF all of the gas control knobs, shut off the fuel supply, and disconnect the fuel line.

The burners can be removed by removing the locking pins and lifting them out. The locking pins are located under the grill toward the back. They are used to keep the burners in place during shipping and are not necessary to operate your grill. Remove burners from the grill by carefully lifting each burner up and away from the gas valve orifice.

Use a wire brush to clean the outer surface of each burner to remove food residue and dirt. Clean any clogged ports with a stiff wire such as an opened paper clip.

Inspect each burner for damage (cracks and holes). If any damage is found, discontinue grill usage until you replace the burner.

Upon reinstallation, inspect the gas valve orifices for cleanliness and condition and the location of the igniters. When you replace the burners, you do not need to replace the locking pins.

Cooking Grates

Use a solution equal parts detergent and hot water just as you would for any cooking equipment. A stiff wire brush or steel wool may also be helpful in removing grime and food deposits.



Note

Do not use a wire brush or stainless steel on any other part of your grill or any other stainless steel surface except the cooking grates or the griddle!

Drip Pan

The full width drip pan will collect grease from the main grill area. The pan should be cleaned after every use to avoid the possibility of a grease fire. Be sure to allow the drip pan to cool prior to cleaning. You may clean the drip pan with a solution of warm soapy water. Make sure to rinse thoroughly to avoid staining.

Griddle

To prevent burns or injury, make sure the griddle is completely cool before cleaning.

The griddle is made from non-magnetic, 304 grade stainless steel. There are various stainless steel cleaners available. Always use the mildest cleaning procedure first, and always scrub in the direction of the grain. Use soapy water for most cleaning. A non-abrasive scrubber may also be helpful in removing grime and food deposits. Steel wool may be used for especially difficult spots. Wipe all areas dry before storing.

Steam Cleaning Your Grill

Steam cleaning the interior of your grill is very effective and will not void your warranty. Portable hand-held steam cleaners are inexpensive and do not require chemicals. You can steam clean all parts of your Cal Flame grill, including the burners. When you are finished, make sure you wipe all surfaces down.

If you spray the burners, ignite them and let them burn for about 10 minutes to prevent any water from accumulating inside them.

Covering Your Grill

When not in use and after cooling, cover your grill with our full length, zippered side canvas cover. (See your local Cal Flame dealer for details.) The cover will help protect your grill from detrimental effects of weather and environmental pollutants. Never put a cover on a hot grill. Allow the grill to cool before covering.

Seasonal Cleaning

If you haven't used your grill in a few months, we recommend that you clean the burners and the interior of your grill. Cleaning the burners periodically will keep them burning evenly and cleanly and help prevent "flashback", a type of fire in and around the gas tubes. This happens when spiders and small insects inhabit or make nests in the burner tubes, obstructing the gas flow.

IMPORTANT: Before removing the burners, turn OFF all of the gas control knobs, shut off the fuel supply, and disconnect the fuel line.

1. Remove the components

Remove the racks, the flavor bars, and the flame tamers from the grill and set them aside. They don't need to be in the grill in order to clean them. In fact, all of the items can be cleaned in a dishwasher if you wish.

Leave the drip pan in place for now.

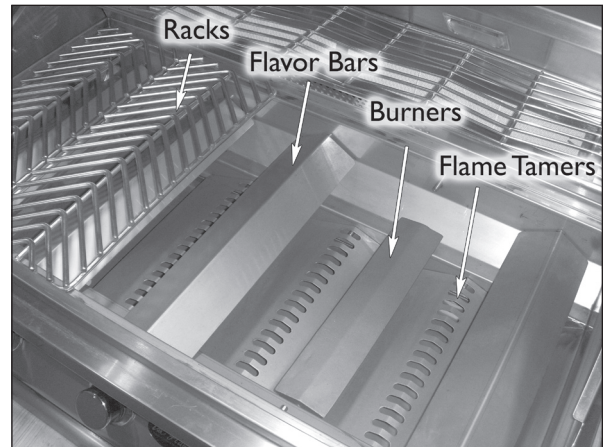

2. Remove the burners

The burners can be removed by taking out the locking pins and carefully lifting them up and away from the valve orifice. The locking pins are located under the grill toward the back. They are used to keep the burners in place during shipping and are not necessary to operate your grill.

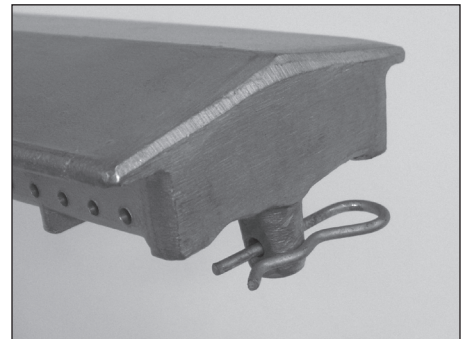

3. Clean the burners

Use a wire brush to clean the outer surface of each burner to remove food residue and dirt. Clean any clogged ports with a stiff wire such as an opened paper clip.

Make sure the flow channel is clear. The flow channel is the narrow slot on the bottom of the burner near the anchor post.

Inspect each burner for damage, such as cracks and holes. If any damage is found, don't use the grill until you replace the burner.

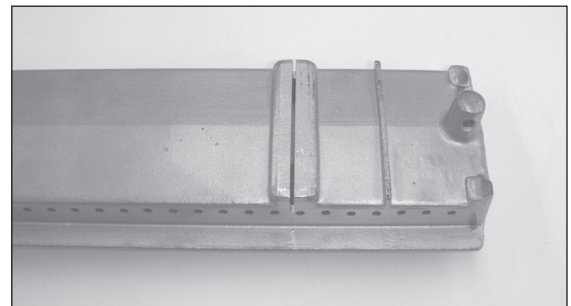
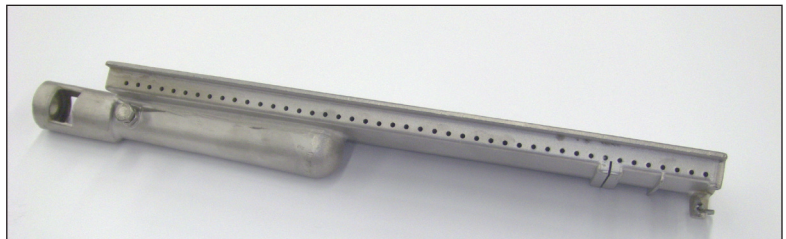

4. Clean the grill interior

While the burners are out of the grill, you can use this opportunity to clean the interior of your grill thoroughly. You should still have the drip pan in place to catch water and grime as you clean the grill interior.

When the grill interior is clean, remove the drip pan. Dump out any water and grime residue and spray it off with a garden hose.

Dry both the grill interior and the drip pan thoroughly to prevent water damage.

5. Clean the components

You can clean the racks by first soaking them in warm water and dish detergent and scrubbing them with a wire brush.

Clean the flavor bars and the flame tamers with dish detergent. You can use any kind of scrubber you wish: a non-abrasive pad, steel wool, or a wire brush, depending on your needs.

Dry all of the components thoroughly to prevent water damage.

6. Replace the burners

Before you replace the burners, inspect the gas valve orifices for cleanliness and condition and the location of the igniters.

Set the flame tamers in place before you replace the burners.

Carefully insert the burner into the opening for the valve orifice and gently slide it in. Then set the other end of the burner down so the anchor post rests in the hole.

When you replace the burners, you don't need to replace the locking pins.

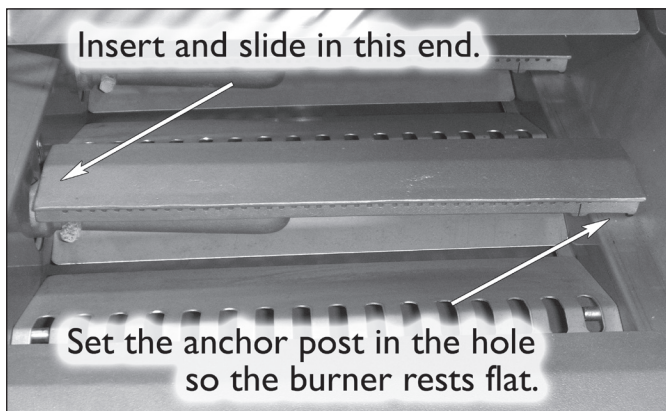

7. Replace the components

Put all of the components back as they were, as shown in step 1.

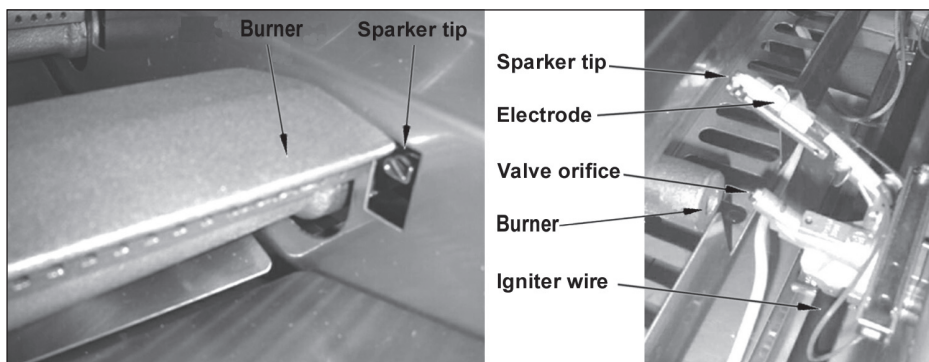

Light Bulb Replacement

WARNING: Never attempt to replace a light bulb when the grill is in use. Serious burns will result.

WARNING: Never touch halogen bulbs with your bare fingers. Use a tissue or a small piece of paper to handle bulbs. Oils from your hands will damage halogen bulbs.

Cal Flame grills use two different types of light housings. These instructions describe how to change the bulb in both types.

Light Lens with Screw Clip

1. Remove the screw at the left or right of the lens.
2. Carefully pull the lens away and out of the light fixture. Set the lens, screw clip, and screw aside.
3. Unscrew the two screws located at the side of the white ceramic light fixture.
4. Using a tissue or small piece of paper, pull the burnt bulb out of the socket.
5. Using a tissue or small piece of paper, carefully push a new bulb into the socket, making sure both wires on the bulb go into the light socket evenly.
6. Tighten the two screws on the side white ceramic light fixture.
7. Replace the light lens by replacing the screw and screw clip.

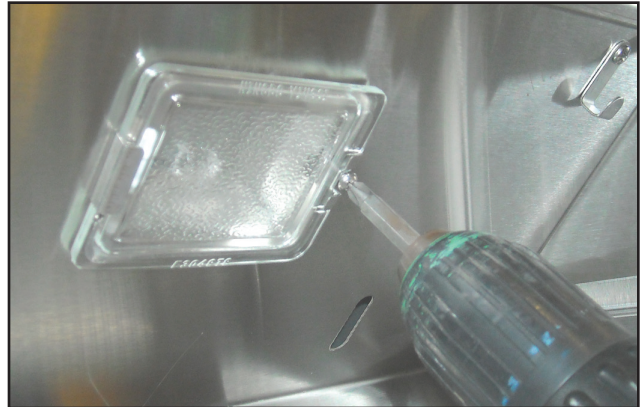

Snap-in Light Lens

1. Using a small standard screwdriver, carefully pop out the light lens and set it aside.
2. Using a tissue or small piece of paper, pull the burnt bulb out of the socket.
3. Using a tissue or small piece of paper, carefully push a new bulb into the socket, making sure both wires on the bulb go into the light socket evenly.
4. Replace the light lens by carefully snapping it back in place



Appendix

Troubleshooting

Problem: Smell of gas is present

Solution: Check for loose connections in the gas line. Perform a leak test following the procedure described in this manual.

Problem: Burner does not ignite

Solution: Note: Turn off the gas at the source while troubleshooting.

Use the following procedure with the figure below.

Check the position of the sparker tip. It should be pointing forward towards the front of the burner.

- Make sure there is a blue spark at the electrode tip to the burner.
- Make sure the igniter wire is connected firmly to the valve ignition device and the electrode.
- Make sure the valve orifice is free of any debris, dust or grease.
- Make sure the valve orifice is aligned inside the front hole of the burner.
- If there is no spark at all, replace the electrode or igniter wire.

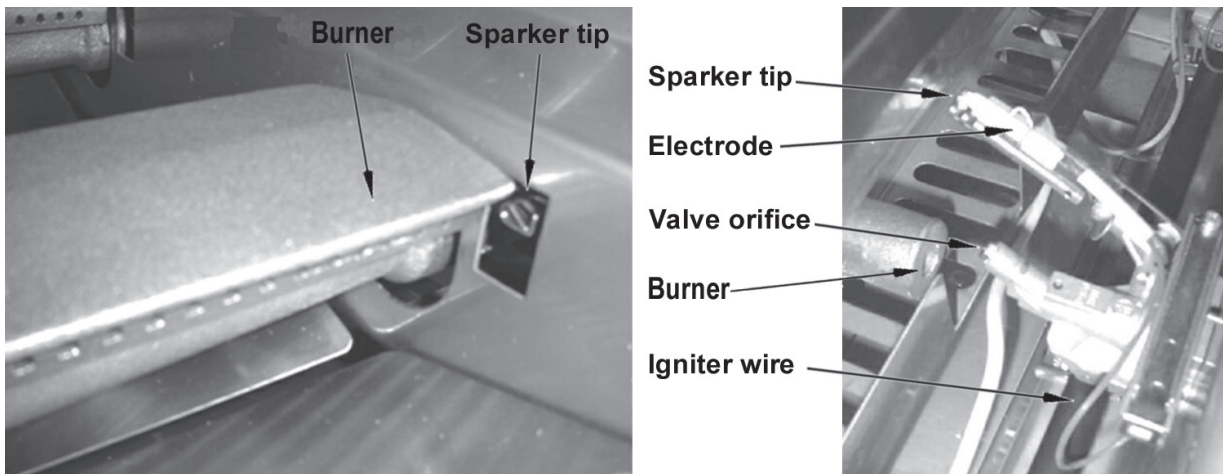

Problem: Burner tube is misaligned over the orifice

Solution: Reposition the burner tube so that it is properly seated over the orifice.

Problem: Obstruction in the gas line

Solution: Remove the fuel line from grill. (Do not smoke or perform any maintenance in the vicinity of an open flame.) Open the gas valve for one second to blow out any debris. Close off the gas valve and reconnect the fuel line securely. Let the area ventilate for a few seconds before reconnecting the fuel line.

Problem: Yellow Flame

Solution: Once the entire burner is operating, check the flame color to be sure that it is mostly blue. Some yellow at the tips may be present due to impurities in the fuel. If the flame is golden or yellow in color, the reason could be seasoning salts, oil film, or other foreign matter on the burner.

Problem: Plugged orifice

Solution: Unplug the orifice as follows:

- Remove cooking grills, flame tamer and grease tray.
- Remove burners from the bottom of the firebox by pulling the locking pin from beneath the burner peg using a standard screwdriver or needle nose pliers.
- Carefully lift each burner up and away from the gas orifice.
- Remove the orifice from the control valve.
- Gently clear any obstruction with a fine wire.
- Reinstall the orifice, reinstall the burners over the orifices, and seat each burner peg into position hole at the bottom ledge of the firebox.
- Replace cooking components and grease collectors.

If an obstruction is suspected in the control valve, contact your local Cal Flame dealer for assistance.

Problem: Misalignment of Igniter on Burner

- Solution:**
- Check for proper position of the electrode tip, which should be pointing forward towards the front of the burner and free of grease to allow proper sparking.
 - The ignition wire should be connected firmly to the valve ignition device and electrode. Replace the ignition wire if it is frayed or cracked.
 - With the gas supply closed and all control knobs set to the off position, check each position igniter individually for the presence of a spark at the electrode. Push each knob in fully and rotate it about 1/4 turn to the left (counter-clockwise) until you hear a loud click. The trigger hitting the strike block should produce a blue spark at the electrode tip. Return control knob to the off position before checking the next igniter.
 - While the grill is still hot, wait for a minimum of five minutes before commencing re-ignition. (This allows accumulated gas fumes to clear.) If all checks / corrections have been made and the gas grill still fails to operate properly, contact your local Cal Flame dealer.

Problem: Flashback

Solution: When fire occurs in and around the burner tubes, immediately turn off gas at its source and turn the control knobs clockwise to the 'OFF' position. Wait until the grill has cooled off and then clean the burner tubes and burners as described on page of this manual.

Converting from LP to NG



WARNING! You must have an authorized service technician perform this procedure. If these instructions are not followed exactly, a fire or explosion may result causing property damage, personal injury or loss of life. Lloyd's Material Supply (LMS) will not be held responsible for an improperly converted gas grill.

All Cal Flame grills are manufactured as standard liquid propane (LP) grills and can be converted to burn natural gas (NG). There are two steps required to convert a grill from LP to NG.

You must perform both steps.

Step 1: Switching the regulator behind the grill

Step 2: Changing the burner orifices

The conversion kit provided with your grill may include **some or all** of the parts shown at right, depending on the size and model of your grill.

The kit contains orifices to convert main burners, rear infrared burners, and the large infrared burner. Your kit will have only the parts you need to convert your grill.

Before you begin, make certain the LP gas source has been disconnected from the grill.

To gain access to the NG regulator, tilt the grill forward.

Conversion kit includes:

- 1 - NG regulator
- 2 - Flared fittings



- 5 - 1.9 mm orifices (main burners)
- 2 - #54 orifices (dual infrared burners) (5 & 3 burner grills)



- 2 - 1.75 mm orifices (side burners)
- 1 - #50 orifice (large infrared burner) (4 burner grill)



You will need:

- Pipe wrench
- Pipe compound suitable for natural gas

Step 1: Attaching the regulator behind the grill

1. Remove the LP gas line and LP gas fitting from end of manifold.
2. Attach NG regulator to end of manifold.

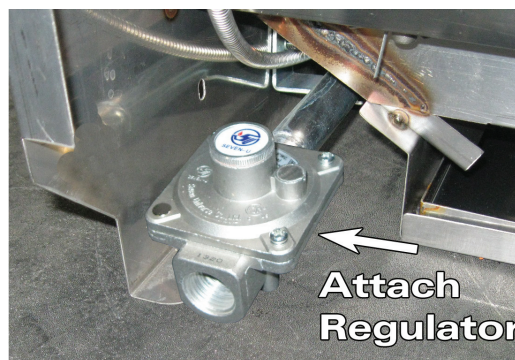
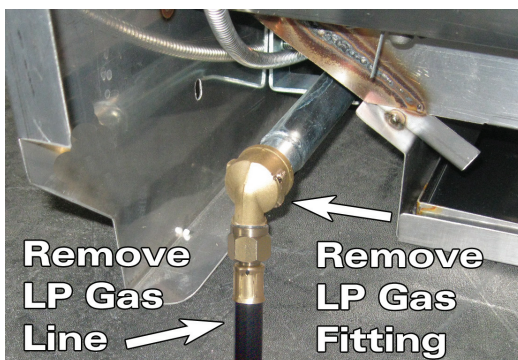

Gas Conversion (continued)

Step 2: Changing the burner orifices

1. Replace the main burner orifices

- a. Remove the grates, flame tamers, and drip tray from the grill. See figure below.

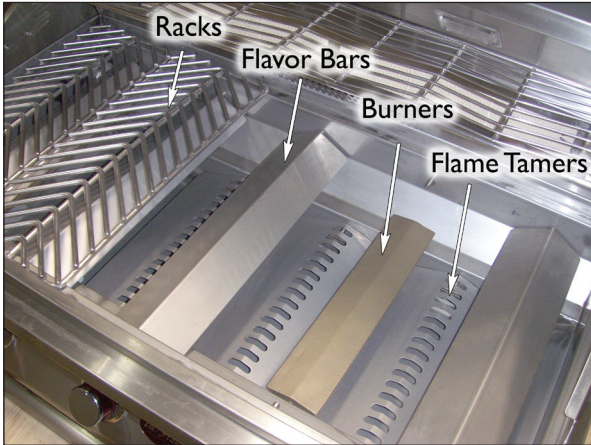

- b. Remove the locking pins from the end of the burners.

The locking pins are accessible by removing the drip tray and tilting the grill back. They can be seen underneath the grill in the back. See figures below.

- c. Remove all burners by carefully lifting them up and away from the valve orifice.

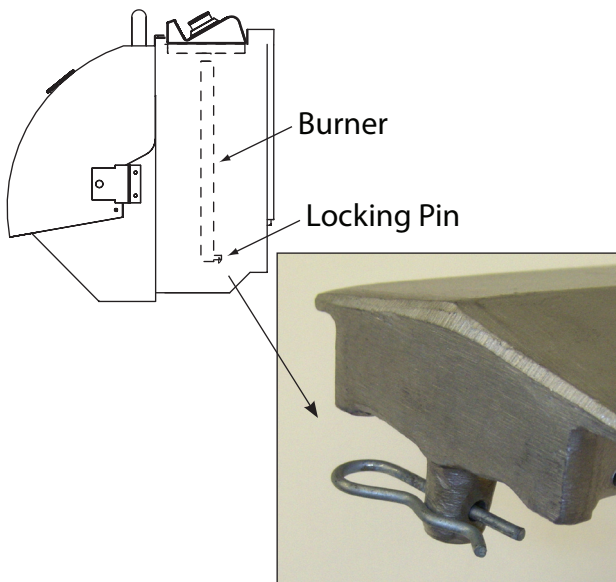

You will need:

- 6mm socket or nut driver
- Two to five 1.9mm orifices (depending on your grill)
- Pipe compound suitable for natural gas

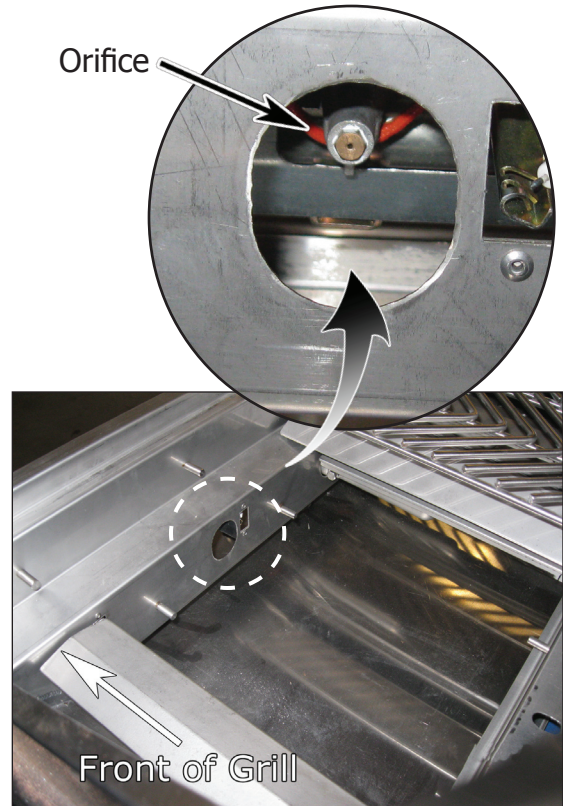

- d. Using a 6mm socket or nut driver, remove the orifice for the burner.
- e. Apply a small amount of pipe compound to the orifice threads.
- f. Screw in the orifice until it is finger tight.
- g. Tighten the orifice with the 6mm wrench.
- h. Repeat the above steps for the remaining burners.
- i. Replace the burners, flame tamers, drip tray, and grates.

You do not need to replace the locking pins. They are used to keep the burners in place during shipping and are not necessary to operate your grill.

Gas Conversion (continued)

2. Replace the infrared burner orifices

You will need:

- Either a 13mm or 10mm open end wrench
- One #50 orifice (for single infrared burner)
OR
- Two #54 orifices (for dual infrared burners)
OR
- One #52 orifice (for single infrared burner)
- Pipe compound suitable for natural gas

- Unscrew the back cover from the grill and lift it up and under the grill hood.



- Using a wrench, remove the orifice for the infrared burner.

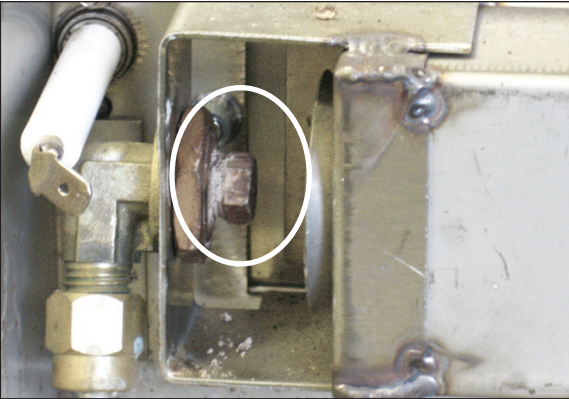

- Apply pipe compound to the fitting threads where you will place the new orifice.
- Screw on the correct orifice for your grill until it is finger tight.
- Tighten the orifice with the wrench.
- If you have dual infrared burners, repeat the previous steps for the second burner.
- Replace the back cover.

3. Replace the side burner orifices

You will need:

- 7mm wrench, socket, or nut driver
- One or two 1.75mm orifices (depending on your side burner)
- Pipe compound suitable for natural gas

- Remove the grate, burner cap and burner diffuser from the side burner.

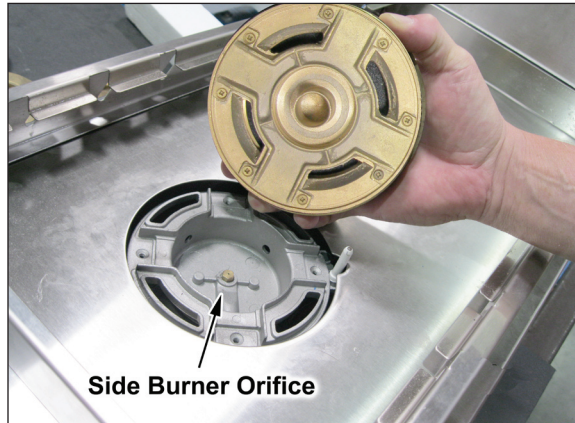

- Using a 7mm wrench, remove the orifice for the burner.
- Apply a small amount of pipe compound to the orifice threads.
- Screw in the orifice until it is finger tight.
- Tighten the orifice with the 7mm wrench.
- If you have dual side burners, repeat the previous steps for the second burner.

4. Mark the rating plate

After conversion has been completed, mark the rating plate as NG with an indelible marker.

Installing Sear Zone Burners

1. Disconnect or shut off the LP or natural gas line connected to the grill. Wait until the burners cool down.
2. Open the hood and remove the grate and flame tamer on top of the stainless steel burner you want to replace.
3. Through the access door underneath the grill, find the round stud and locking pin that locks the burner you want to replace.
4. Carefully remove the locking pin with your fingers.
5. Raise the stud from the locking hole and carefully move the burner forward to release it from the igniter and gas supply valve.
6. Take the burner out of the grill and store it in a safe and dry place.
7. Install the Sear Zone burner. Align the gas inlet on the burner with the gas supply valve on the grill and torch tube with the igniter. Make sure they align perfectly. Slide the stud at the other end into the locking hole.
8. Adjust the Sear Zone burner, make sure the burner is aligned and in position.
9. Repeat steps 2 through 9 if you want to replace other burners.
10. Put back the grate you just removed. (You don't need flame tamers for Sear Zone burners.)

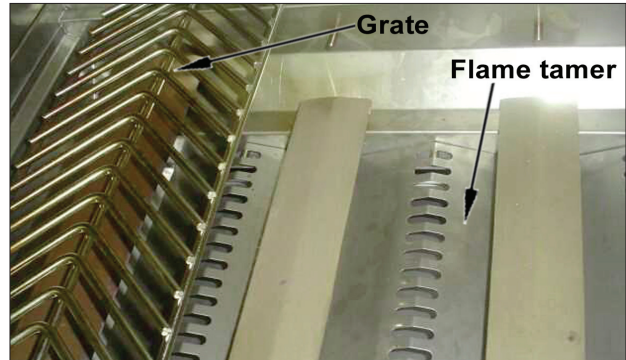

11. Reconnect or turn on the gas line.

If you want to change Sear Zone burners to regular burners, just follow the above procedure above in a similar way.

One Sear Zone burner installed



Multiple Sear Zone burners installed

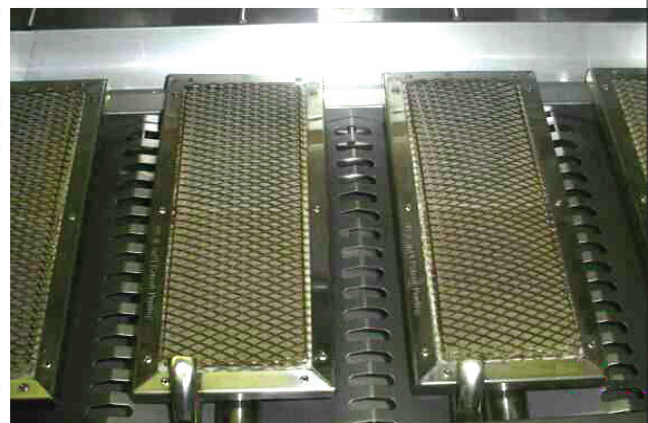

Wiring Diagram

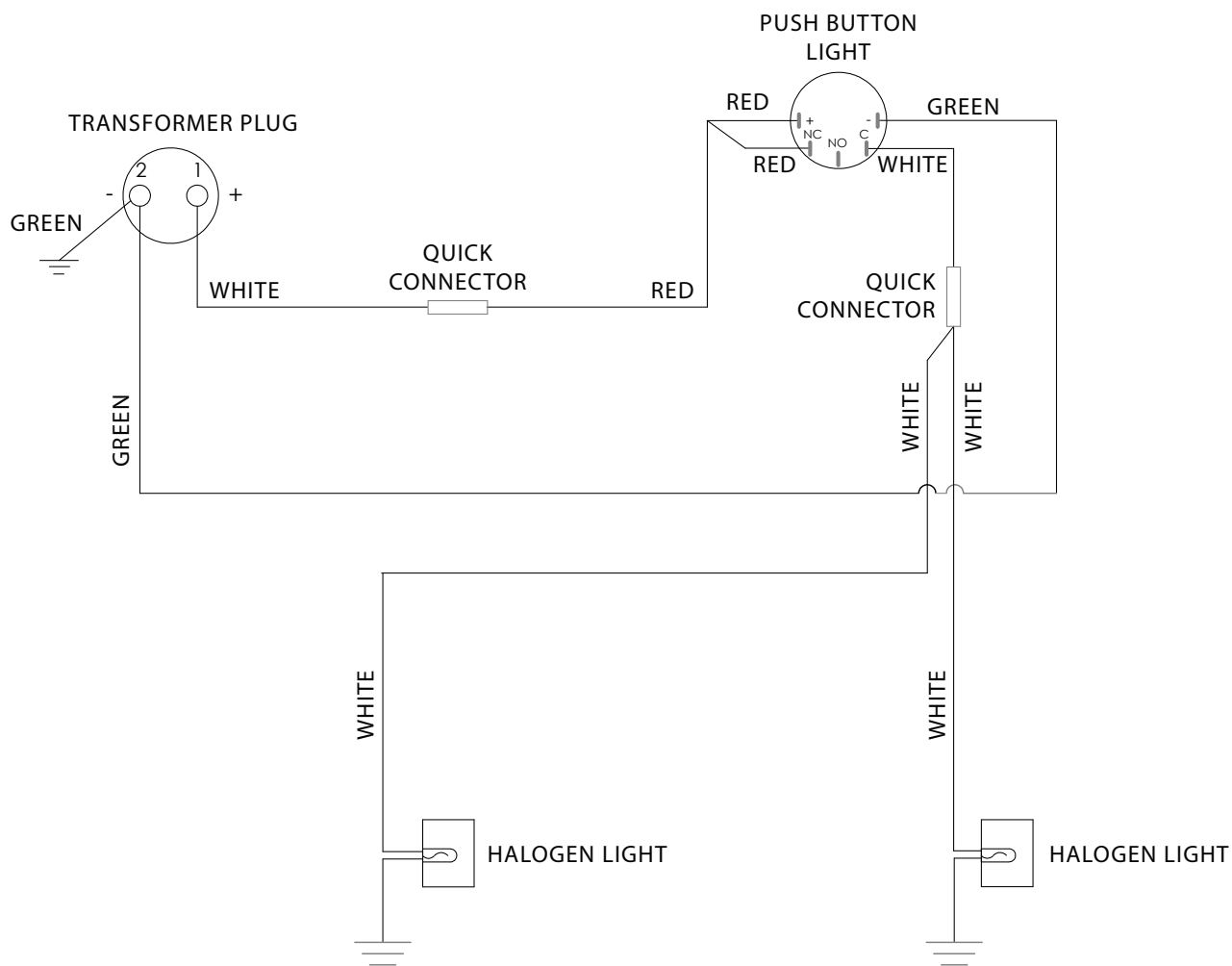

NOTE:
USE TERMINAL CONNECTORS TO ALL WIRE ENDS THAT CONNECT TO ALL ELECTRICAL COMPONENTS. NO SOLDERING.

Replacement Parts

To order replacement parts, either contact an authorized selling dealer or visit www.quickbbqparts.com. See following page for part numbers.

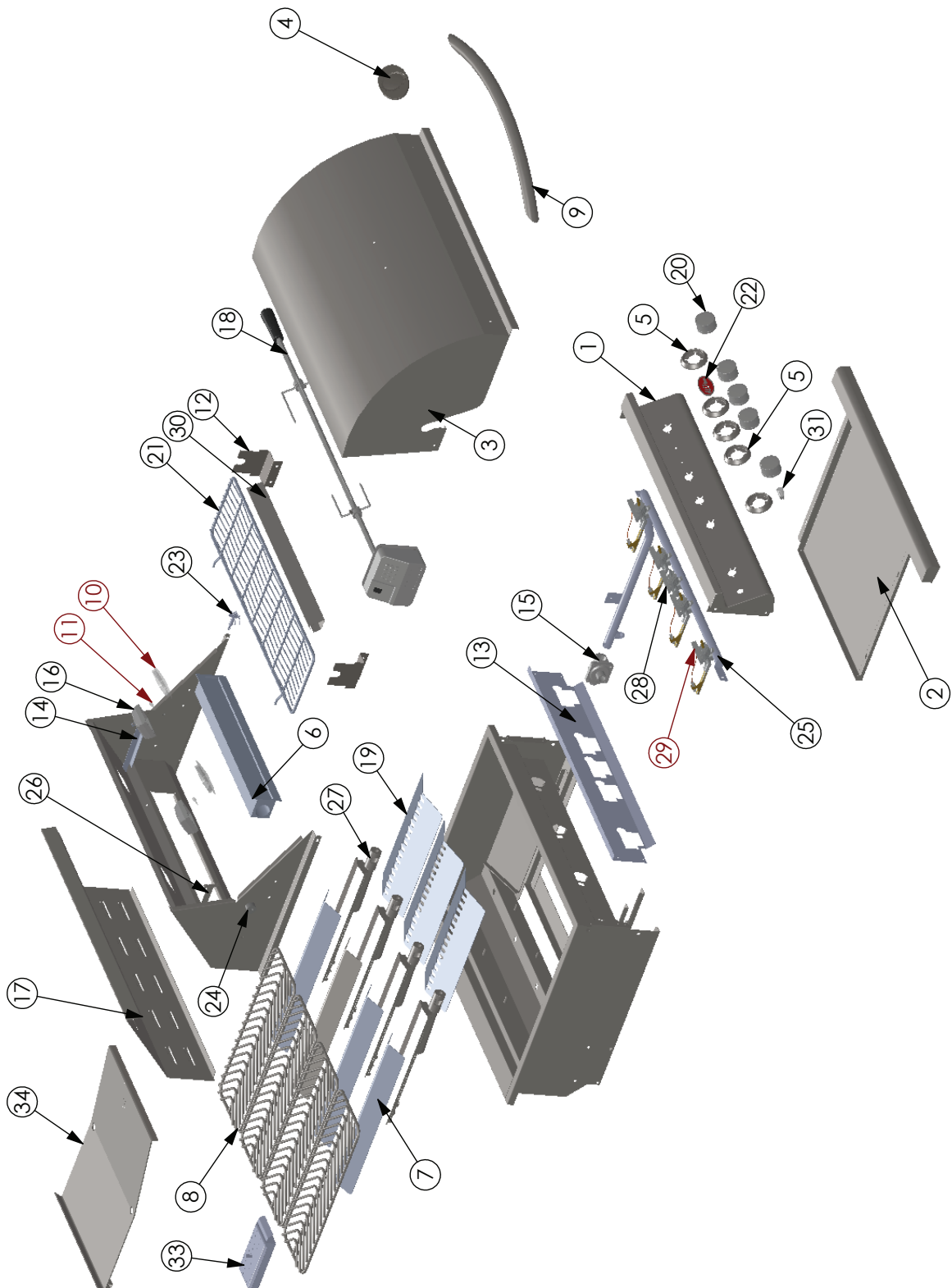

Item No.	Part	Grill Size	Part #
1	Control panel	4 burner	BBQ10104050-CC
		5 burner	BBQ10104051-CC
2	Drip pan	4 burner	BBQ07100687
		5 burner	BBQ07100688-CC
3	Hood	4 burner	BBQ07100588-CC
		5 burner	BBQ07100589-CC
4	Thermometer	All	BBQ07410350
5	Bezel	All	BBQ08410351
6	Back burner	4 burner	BBQ07300440
		5 burner	BBQ07300430
7	Flavor bar	All	BBQ04103000
8	Grates	All	BBQ04100659
9	Handle	4 burner	BBQ07100639
		5 burner	BBQ07100641
10	Light lens	All	BBQ04103059
11	Halogen lamp	All	LIT16300031
12	Rotisserie bracket	All	BBQ04100786
13	Convection panel heat shield	4 burner	BBQ07220170
		5 burner	BBQ07200171
14	Upper rack holder, right side	All	BBQ04100707
15	Regulator (NG)	All	BBQ04103041
	Regulator with hose (LP)	All	BBQ04101043
16	Light housing	All	BBQ10103070
17	Back panel	4 burner	BBQ07104054
		5 burner	BBQ07104055
18	Spit rod assembly	4 burner	BBQ08856P4
		5 burner	BBQ08856P5
19	Flame tamer	All	BBQ04103010-CC
20	2" knob	All	BBQ04101028
21	Warming rack	4 burner	BBQ08100657-CC
		5 burner	BBQ08100658
22	Cal Flame logo	All	BBQ04100972
23	Back burner electrode	All	BBQ04101809
24	Hood hinge	All	BBQ04101257
25	Manifold	4 burner	BBQ08000514
		5 burner	BBQ08000515
26	Upper rack holder, left side	All	BBQ04100706
27	Stainless steel burner	All	BBQ07100661
28	Back burner valve (LP)	All	BBQ04101014
	Back burner valve (NG)	All	BBQ04101013

29	Main burner valve (LP)	All	BBQ04101016
	Main burner valve (NG)	All	BBQ04101015
30	Back burner deflector	All	BBQ08300441
31	Button light switch, PV3F2G0SS	All	BBQ04300425
32	120V rotisserie motor		
33	Smoke tray	All	BBQ13855P
34	Removable plate griddle	All	BBQ13867
	Grill cover (not shown)	All	BBQCP4-B

LIMITED WARRANTY

All Cal Flame models are manufactured with the highest quality appliances and are warranted to be free from defects in material and workmanship at time of delivery.

LMS warrants barbecue grills and associated hardware from deterioration, corrosion, and defects in material and workmanship for a period of one year from the original date of delivery, with the exception of plastic items and glass light covers, which are warranted for 90 days.

Extent of Warranty

This limited warranty is only valid on Cal Flame models delivered in the United States or Canada and extends through the selling dealer to the original purchaser at the original site of installation. This warranty becomes valid at time of delivery and ends either by specified time-frame listed above or upon owner transfer or relocation.

Warranty Performance

In the event of a malfunction or defect covered under the terms of this warranty, contact either the selling dealer or a local contractor or service technician. Depending on your needs, this may be a contractor qualified to repair stone and tile or a service agent licensed to repair gas or electrical appliances.

In the event the consumer is unable to obtain satisfactory customer service from the selling dealer or service agent, written notification must be given to the LMS Customer Relations Department within 30 days of the reported failure.

There will be no charge for parts on a covered item. Cost of labor is the responsibility of the owner. Shipping and handling charges will apply to all warranted replacement parts. The service agent may assess a reasonable travel or mileage charge per service call. If LMS determines that repair of a covered item is not feasible, LMS reserves the right to replace the defective merchandise with merchandise equal in value to the original purchase price. Warranty repair and / or replacement are the sole discretion of LMS and this warranty does not cover costs therein, including but not limited to: freight, removal, re-installation, etc.

This warrant is non-transferable and may not be extended beyond the above mentioned time frames under any circumstances, by any of LMS's representatives.

Warranty Limitations

The stainless steel grill hood, stainless steel grill racks, and the optional fabric grill cover are not covered by this warranty.

This warranty is void if the barbecue grill has been subject to negligence, alteration, misuse, repairs, dings, dents, scratches, or incorrect and / or prohibited applications, as specified in the owner's manual. Gas lines must be installed by a licensed plumber only or local gas company agent. Incorrect electrical installation by unlicensed electricians, service by non-LMS authorized representatives, acts of God and other cases beyond the control of LMS are not covered by this warranty. Please refer to the owner's manual for examples of exclusions and common acts invalidating this warranty.

This limited warranty applies only to barbecue grills and associated hardware used for personal, family, and outdoor household purposes. This warranty does not apply to labor charges on grills, replacement parts and hardware. This limitation is retroactive and applies to all grills and hardware manufactured from 2000 and hereafter.

Examples of common acts invalidating this warranty include but are not limited to:

- Scratches caused by normal use.
- Damage caused by extreme weather conditions (hot, cold, etc.)
- Damage caused by salty and humid conditions (especially in beach or seaside communities)
- Damage caused by dirt, sand, and/or water damage.
- Damage caused by continued operation of the barbecue with either known or unknown problems.
- Damage caused by direct sunlight.
- Damage caused as a result of failure to follow the operating instructions as defined in this owner's manual.

This limited warranty applies only to barbecues normally used for personal, family, or household purposes and specifically excludes rental or commercial applications.

Disclaimers

LMS shall not be liable for loss of use of the barbecue grills, related hardware or other incidental or consequential costs, expense or damages, which may include, but are not limited to, removal of permanent deck or other custom fixtures or the necessity for crane removal. Any implied warranty shall have duration equal of the applicable warranty stated above.

Legal Remedies

This limited warranty gives you specific legal rights. You may have other rights, which may vary from state to state.

Customer Service

For customer service, contact the authorized selling dealer immediately. If you need additional information or assistance, please contact the LMS Customer Relations Department at 1462 E. Ninth St., Pomona CA 91766 or call (800) 225-7727.

See your Cal Flame barbecue dealer for a copy of the applicable warranty, details and any questions you may have regarding the warranty coverage on your barbecue.

Locating the product serial number

The serial number of your Cal Flame grill is located on the back and is visible when the hood is down. You will need this number to properly register your grill and activate coverage. Write this information in the space provided below.



Grill model: _____

Grill serial number: _____

Type of fuel (circle one): Liquid propane Natural gas

Date purchased: _____

Date installed: _____

Cal Flame dealer's phone number: _____

Cal Flame dealer's address: _____

Don't forget to register your new product at

www.calflamebbq.com.

Cal Flame
www.calflamebbq.com

California Proposition 65 Warning: Chemicals known to the State of California to cause cancer, birth defects or other reproductive harm are found in and/or created by the combustion of natural gas, propane, butane and other fuels. Always operate this unit as described in the owner's manual and in well ventilated areas.

LTR50001137, Rev. B
12/26/13