

# Cal Flame®

2-in-1 Oven  
Warmer and Pizza Oven

BBQ14967E

United States and Canada

## Owner's Manual

© 2019 LMS



<b>Safety Instructions</b> .....	<b>1</b>
<b>Cut-Out Dimensions</b> .....	<b>3</b>
<b>Set-up</b> .....	<b>4</b>
<b>Using Your Oven</b> .....	<b>6</b>
<b>Care and Maintenance</b> .....	<b>11</b>
<b>Limited Warranty</b> .....	<b>12</b>

**This appliance is for personal, family, or household purposes only and specifically excludes commercial use.**

Use the pizza oven only for its intended purpose as described in this guide.

Read and follow all instructions before using this appliance to prevent the potential risk of fire, electric shock, personal injury or damage to the appliance as a result of improper usage of the appliance. Improper installation, adjustment, alteration, service or maintenance can cause injury or property damage.



**WARNING!** Proposition 65 Warning: Handling the brass material on this product exposes you to lead, a chemical known to the State of California to cause cancer, birth defects or other reproductive harm. (Wash hands after handling this product.)

This product and the fuels used to operate this product (propane or natural gas), and the products of combustion of such fuels, can expose you to chemicals including Benzene, which is known to the state of California to cause cancer and birth defects or reproductive harm.

For more information go to [www.P65Warnings.ca.gov](http://www.P65Warnings.ca.gov).

**Electrical Specifications:**

- 115 volts
- 15.0 amps
- 1265 watts

Copyright 2019 LMS. All rights reserved. Duplication without written consent is strictly prohibited.

Cal Flame® is a registered trademark.

Due to continuous improvement programs, all models, operation, and/or specifications are subject to change without prior notice.

LTR50001052, Rev. H  
10/29/19

<p><b>CONTACT INFORMATION</b></p> <p>For customer service, please contact your authorized dealer immediately. If you need additional information and/or assistance, please contact:</p> <p>Customer Service Department 1462 East Ninth Street Pomona, CA 91766</p> <p>Toll Free: 1-800-225-7727 Fax: 1-909-629-3890</p> <p><b><a href="http://www.calflamebbq.com">www.calflamebbq.com</a></b></p>
--

# Safety Instructions

## In Case of Smoke or Fire

**This is an electrical appliance -- do not spray water into the oven!**

- Turn off the power **IMMEDIATELY**.
- Use a pizza peel to remove any smoking, burning, or charred food. **Do not reach your hands into the oven!**
- Place the food someplace safe, such as on top of the barbecue island, and if it is burning, extinguish it.
- Leave the door to the pizza oven open to let it ventilate.

## Placement and Location

**The Cal Flame electric pizza oven is designed for outdoor use only.**

- Never locate this appliance in an enclosed area, under a sealed overhead structure, or in any type of enclosed area such as a garage, shed, or breezeway. Keep clear of trees and shrubs.
- The electric pizza oven is not intended for installation in or on recreational vehicles or boats.
- Do not use the pizza oven as a storage area.

## Operation

- **Always ensure food does not come in contact with the heating element located at the top of the oven.**
- **Do not use fuel such as charcoal briquettes in an electric oven.**
- Do not use pizza oven for other than intended use.
- Never leave oven unattended when in use. Turn off oven when finished.
- When using the pizza oven, do not touch the rack, hearth bricks, heating element, or immediate surroundings as these areas become extremely hot and can cause burns.

- Do not heat any unopened glass or metal container of food in the oven. Pressure may build up and cause the container to burst, possibly resulting in serious personal injury or damage to the oven.
- Do not operate the oven with a damaged heating element.
- Do not allow the hearth bricks or oven floor to become encrusted with food run-off. Clean frequently.
- Do not completely cover the cooking rack. Leave air space to allow proper ventilation for even baking.

## Precautions Regarding Children

- Never leave children unattended in the area where the oven is being used. Close supervision of children is necessary when any appliance is use near children.
- Children must be taught that the appliance and utensils in or on it can be hot. Let hot utensils cool in a safe place, out of reach of small children. Children should be taught that an appliance is not a toy. Children should not be allowed to play with controls or other parts of the unit.



**WARNING!** Proposition 65 Warning: Handling the brass material on this product exposes you to lead, a chemical known to the State of California to cause cancer, birth defects or other reproductive harm. (Wash hands after handling this product.)

This product and the fuels used to operate this product (propane or natural gas), and the products of combustion of such fuels, can expose you to chemicals including Benzene, which is known to the state of California to cause cancer and birth defects or reproductive harm.

For more information go to [www.P65Warnings.ca.gov](http://www.P65Warnings.ca.gov).

## Cut-Out Dimensions

If you purchased your electric pizza oven with the intention of installing it in a barbecue island, use the diagram below to help you with placement and dimensions.

You need to have a dedicated 110V grounded electrical outlet to plug the pizza oven into. We strongly recommend having a contractor install a dedicated electrical service for your barbecue island. Do not use an extension cord.

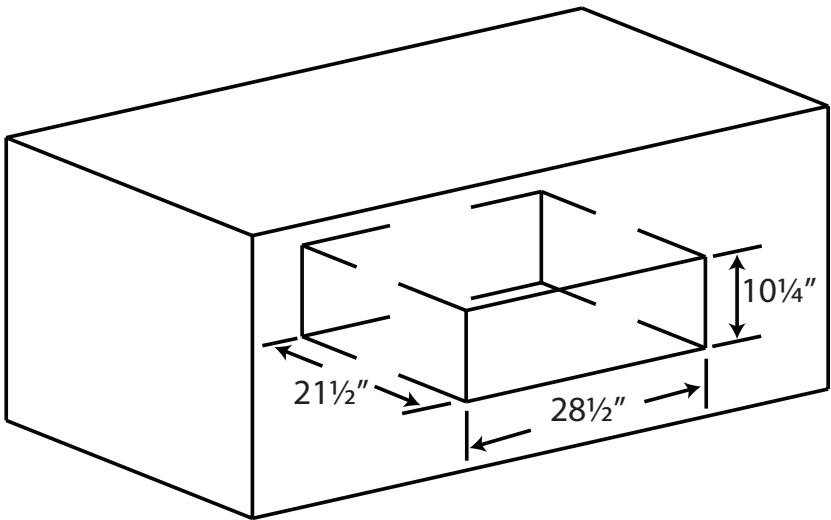

## Set-up

If your electric pizza oven is already installed in a Cal Flame barbecue island, it is nearly ready to use.

Make sure all materials and packaging have been removed from inside the oven.

### Hearth Bricks

The hearth bricks are not required for the pizza oven and do not need to be set in place during the oven's operation. *Their use is entirely optional, and they are included only for those who wish to use them.*

The hearth bricks act as a heat sink, slowly absorbing heat in order to radiate it directly to food placed on top of it. When used in the pizza oven, they absorb heat very slowly and become useful only after heating about 90 minutes (1½ hours), and their temperature never exceeds 425°F. If you prefer to use the oven without them, it is perfectly safe.

However, if you wish to use the hearth bricks, remove them from their packaging and place them in the oven lengthwise from front to back as shown below. One side of the bricks has a smoother texture than the other. We recommend placing the bricks in the oven with the smooth texture up for easier cleaning.

Before placing the stones in the oven, wipe them down with a moist cloth to remove dust and residue.

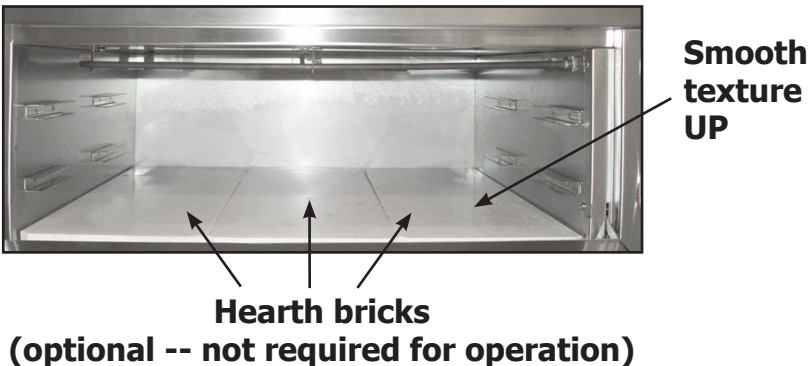

## Thermostat Sensor

You will find the thermostat sensor attached to the oven ceiling. It should be attached to a clip in the center of the heater element. Before you use the oven, check the sensor to make sure it is securely in place and not touching heating element. If the sensor has come loose during shipment, re-insert it into the mounting clip. It can be held in place with a piece of non-insulated wire as shown below.



## Stainless Steel Racks

Slide the stainless steel rack in the side brackets. The rack can be set at two levels.

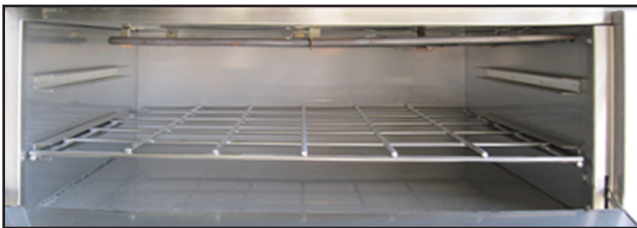

← **Upper  
Level**

← **Lower  
Level**

## Using Your Oven

### Read all instructions before you operate your oven.

The 2-in-1 oven is suitable for cooking, baking, warming, or re-heating a variety of foods, such as pizza, pretzels, biscuits, cookies, bagels, sandwiches, french fries, or onion rings.

Food items that requires significant rising when baking, such as bread, high rising cakes, etc., should not be baked in the 2-in-1 oven.

### Interior Dimensions

The figure below shows the total usable area inside the oven. If you buy a pizza pan or cookie sheet, make sure it isn't larger than the interior of the oven.

**Width: 22"**

**Height: 6½"**

**Depth: 19½"**

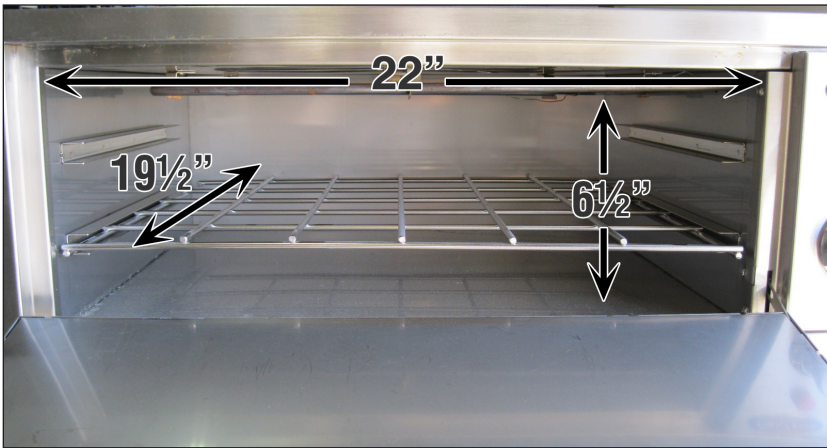

### Setting the Temperature

Preheat the 2-in-1 oven before using.

Turn the dial on the right side of the oven to the desired temperature. Note that the temperature markings on the dial are approximate and the temperature can vary considerably. Use the figure at right as a more accurate temperature guide.

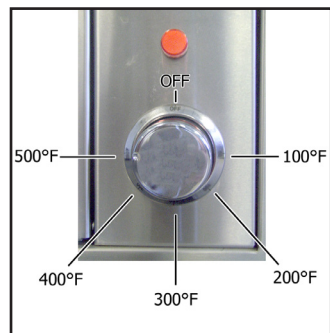



Note that the maximum temperature of the oven without the hearth bricks can exceed 500°F.

The power light will turn on when the oven is in use. During operation, the thermostat will cause the light will go off when the oven has reached set temperature and turn back on when the oven has cooled and requires reheating to reach set temperature.

Oven temperatures are approximate. The actual temperature in your oven can vary depending on local weather conditions (extreme heat or cold) or the nature of your barbecue island.

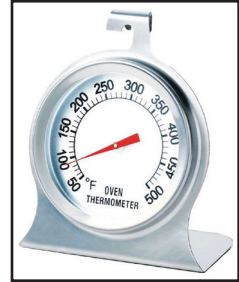

Because the oven does not have a built-in thermometer, we recommend you use an oven thermometer to better determine the actual temperature of the oven.

When the oven has heated, avoid opening the door frequently. You lose valuable heat, which requires more time to re-heat the oven and cook your food.

### Approximate heating times

Refer to the figure on the previous page for dial setting temperatures.

Setting	Heating time without the hearth bricks	Heating time with the hearth bricks
100°F	4 mins	4 mins
200°F	6 mins	13 mins
300°F	10 mins	23 mins
400°F	16 mins	43 mins
500°F	22 mins	60 mins

Note: When you use the oven with the hearth bricks, the maximum temperature you can achieve will be 450°F.

**Note: You can cook food on the bricks, but only after they have been sufficiently pre-heated (as described on page 4). Pre-heating the oven bricks to a useful temperature requires at least 90 minutes.**

## Vent Slides

You can adjust the temperature with the vent slides located inside the door as shown below.

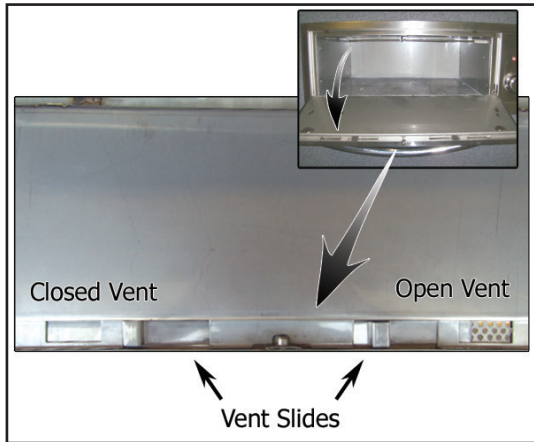

## Placing Food in the Oven



### Caution! Burn Hazard!

The heating element is not shielded. You need to exercise caution when placing food in the oven and removing it.

Never touch the heating element. The heating element may be hot even though it is dark in color. Areas near the element may become hot enough to cause burns.

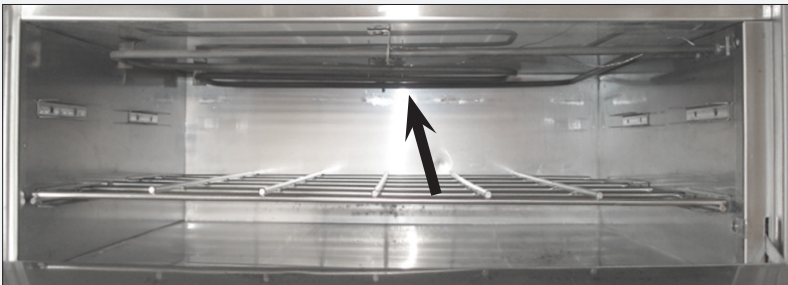

We recommend you use a pizza peel (a tapered wooden paddle) to get your food in and out of the oven.

Note: Pizza peel is NOT provided with oven.

If you do not use a pizza peel, we strongly recommend using oven mitts, and not pot holders, to remove your food from the oven.



**Always ensure food does not come in contact with the heating element located at the top of the oven.**

Do not attempt to remove the heating element. It is not removable.

You can cook pizza directly on the oven rack, although we recommend using a pizza pan, which will help prevent drip and food residue on the oven floor.



The 2-in-1 oven includes two stainless steel warming pans with matching lids. Slide the rack into the lower brackets and place the pans on the rack.

Always use oven mitts to slide the rack out, lift the pan lids, or remove the warming pans.



## Care and Maintenance

To assure safe and proper maintenance, we recommend you follow these directions carefully.

Clean internal parts of the oven regularly as determined by the amount of use and foods cooked. The entire oven should be cleaned at least once a year.

### Heating Element

Do not remove the heating element. Any food that may collect on it will burn off.

### Hearth Bricks and Rack

Wash the rack with detergent in hot water in the sink or in the dishwasher. Do not immerse a hot rack in water. Be sure to remove all food residue before cooking on the rack again.

### Care of Stainless Steel

Do NOT use wire wool pads, scrappers, harsh abrasive, scoring materials, bleaches, or harsh cleaners. This will cause scratching, scoring, rusting and pitting.

We recommend that you clean stainless steel components with a cleaner that is approved for stainless steel and only clean when the oven is cool and in indirect light. Never use steel wool.

### Control Area

Use mild cleaners, such as soapy water or mild liquid sprays. Wipe with sponge, damp cloth or paper towel. Do not scrub with steel wool pads or abrasive cleaners.

# Limited Warranty

Lloyds Material Supply (LMS) warrants the 110V electric 2-in-1 pizza and warmer oven from defects in material and workmanship for a period of 90 days from the original date of purchase.

## Extent of Warranty

This warranty is only valid on Cal Flame 110V electric 2-in-1 oven delivered in the United States or Canada and extends through the selling dealer to the original purchaser at the original site of installation. This warranty becomes valid at time of purchase and ends either by specified time-frame listed above or upon owner transfer or relocation.

## Warranty Performance

This Cal Flame product is manufactured with the highest quality materials and is warranted to be free from defects in material and workmanship at time of delivery. In the event of a malfunction or defect covered under the terms of this warranty, a factory authorized service agent of LMS will perform the necessary repairs. To obtain service, contact the selling dealer. In the event the consumer is unable to obtain satisfactory customer service from the selling dealer or service agent, written notification must be given to the LMS Customer Relations Department within 30 days of the reported failure.

There will be no charge for parts on a covered item. However, labor charges are the responsibility of the product owner.

The service agent may assess a reasonable travel or mileage charge per service call. If LMS determines that repair of a covered item is not feasible, LMS reserves the right to replace the defective merchandise instead. Warranty repair and / or replacement is the sole discretion of LMS and this warranty does not cover costs therein, including but not limited to: freight, removal, re-installation, etc.

This warranty is non-transferable and may not be extended beyond the above mentioned time frames under any circumstances, by any of LMS's representatives.

## Warranty Limitations

This warranty is void if the product has been subject to negligence, alteration, misuse, repairs, dings, dents, scratches, or incorrect and / or prohibited applications, as specified in the owner's manual. Service by non-LMS authorized representatives, acts of God and other cases beyond the control of LMS are not covered by this warranty.

Examples of common acts invalidating this warranty include but are not limited to:

- Scratches caused by normal use.
- Damage caused by extreme weather conditions (hot, cold, etc.)
- Damage caused by dirt, sand, and/or water damage.
- Damage caused by continued operation of the oven with either known or unknown problems.
- Damage caused by direct sunlight.
- Damage caused as a result of failure to follow the operating instructions as defined in this owner's manual.

This limited warranty applies only to products used for personal, family, or household purposes and specifically excludes commercial use.

## **Disclaimers**

LMS shall not be liable for loss of use of the product or other incidental or consequential costs, expense or damages. Any implied warranty shall have duration equal of the applicable warranty stated above.

## **Legal Remedies**

This limited warranty gives you specific legal rights. You may have other rights, which may vary from state to state.

See your Cal Flame dealer for a copy of the applicable warranty, details and any questions you may have regarding the warranty coverage on your electric oven.



LMS Customer Service Department  
1462 East Ninth Street  
Pomona, CA 91766

Toll Free: 1-800-225-7727

Fax: 1-909-629-3890

**[www.calflamebbq.com](http://www.calflamebbq.com)**



**WARNING!** Proposition 65 Warning: Handling the brass material on this product exposes you to lead, a chemical known to the State of California to cause cancer, birth defects or other reproductive harm. (Wash hands after handling this product.)

This product and the fuels used to operate this product (propane or natural gas), and the products of combustion of such fuels, can expose you to chemicals including Benzene, which is known to the state of California to cause cancer and birth defects or reproductive harm.

For more information go to [www.P65Warnings.ca.gov](http://www.P65Warnings.ca.gov).