

NUM	BBQ LINE
MODEL	FRP908
LINE	

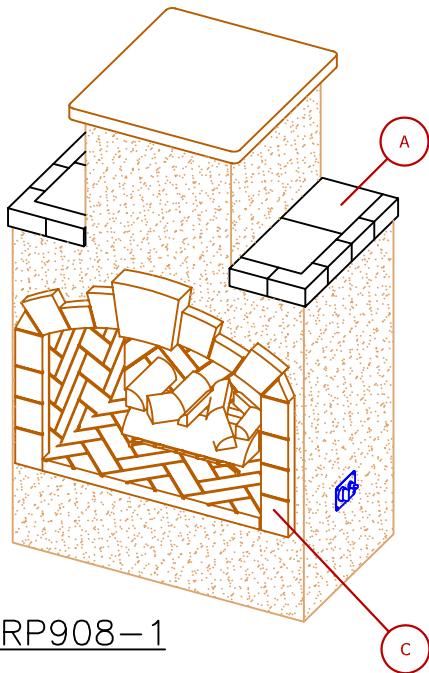

FRP908-1

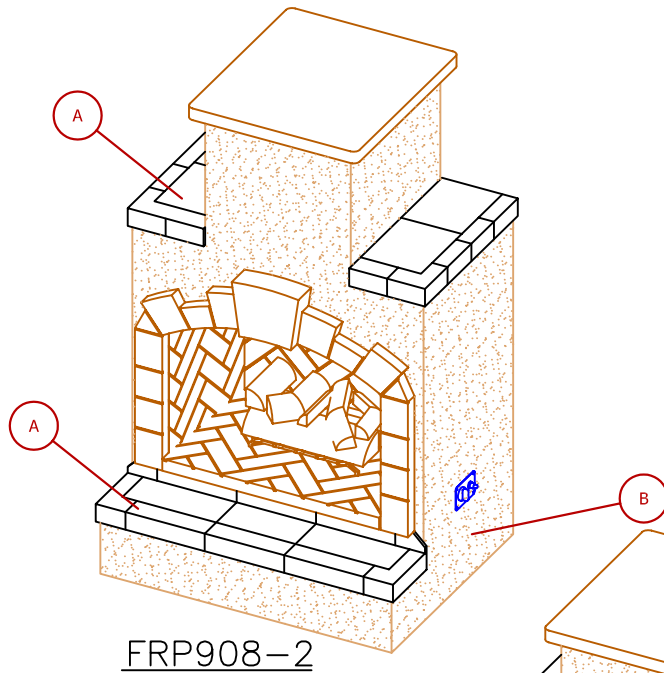

FRP908-2

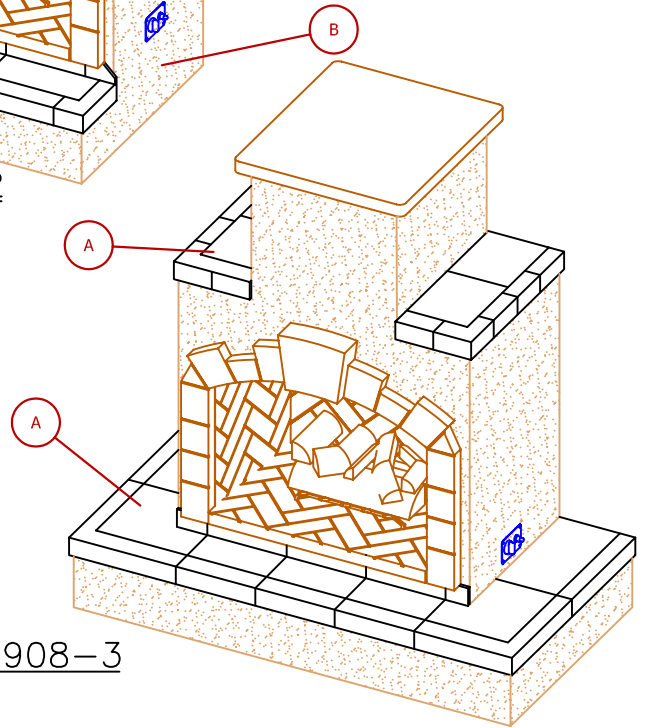

FRP908-3

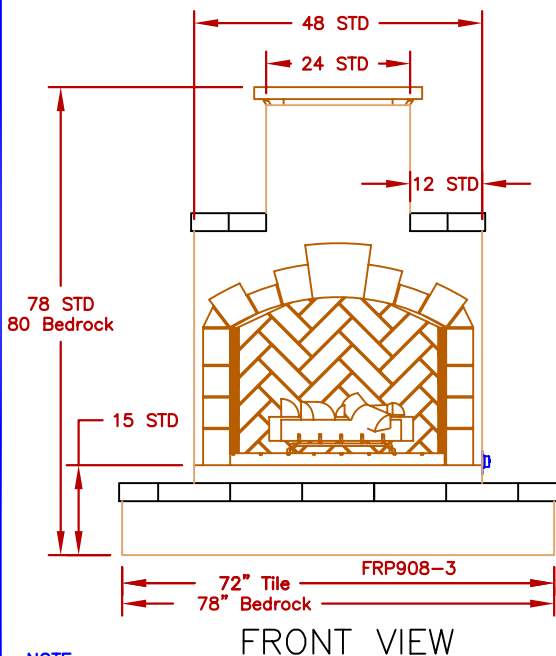
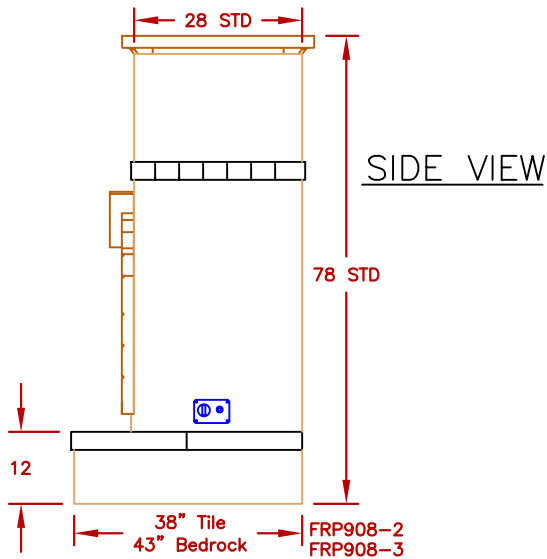

OPTIONS		
SYMB.	DESCRIPTION	OPT#
OPT1	CULTURE STONE	OPTQ825
OPT2	NATURAL STONE TILE (FIELD) (BORDER)	OPTQ860

STANDARD FEATURES		
QTY.	SYMB.	DESCRIPTION
-	(A)	PORCELAIN TILE 12 X 12 (FIELD) (BORDER)
-	(B)	AMERISTONE STUCCO STANDARD FINISH
1	(C)	36" FIBERGLASS W/ ARCH
1	(D)	BURNER BTU OUTPUT 55,000
1	(E)	18" GRATE
-	(F)	STAND. FIRE LOGS SET W/ LAVA ROCKS [7] 24"
1	(G)	LP STAND. NG CONVERTER
-	(H)	VENTILATION

NOTE:
DUE TO OUR CONTINUOUS IMPROVEMENT PROGRAM, ALL MODELS
AND SPECIFICATIONS ARE SUBJECT TO CHANGE WITHOUT NOTICE.

	TITLE 2017 BARBECUE LINE FIREPLACE SERIES FRP908	
	SCALE:	DWG NO.
REVISED	REV. DESCR.	DWG BY G.GARCIA
		DATE 12/14/16